



Industrial PC Solutions



A ROCKWELL AUTOMATION COMPANY

Contents

ASEM CORPORATE

More than 40 years of innovation Made in Italy	4
ASEM A Rockwell Automation Company	6
Milestones	8
The seamless integration of hardware and software technologies is key to success	10
High quality production	12
Solutions for a connected and smart factory	14

INDUSTRIAL PC SOLUTIONS

Industrial PC & Monitor features	18
Custom Solutions	20
ASEM Standards	21
Software solutions for the industrial automation	23
Product Portfolio	26

Panel ARM based

RT25	29
RT30	30
RT35 / RT35Q	32
RT40 / RT40Q	34

Panel IPC

HT2150 / QT2150	38
HT2200 / QT2200	40
HT2250 / QT2250 <i>new</i>	42
HT3200 / QT3200	44
HT3500 / QT3500 <i>new</i>	46
HT3400/3600 / QT3400/3600	48
HT5400/5600 / QT5400/5600	50

Book Mounting IPCs

BM40	54
BM1xx family <i>new</i>	56
BM100	57
BM110 <i>new</i>	58
BM120 / BM121 / BM122 <i>new</i>	59
BM130 / BM131 <i>new</i>	60

BM2150	62
BM2200	64
BM2250 <i>new</i>	66
BM3300 / BM3500	68
BM3400 / BM3600	70

Box IPCs

PB2150	74
PB2200	76
PB2250 <i>new</i>	78
PB3200	80
PB3500 <i>new</i>	82
PB3400 / PB3600	84
PB5400 / PB5600	86

Arm Mounting IPCs

VK3200	90
VK3500 <i>new</i>	92
VPC2200	94

Rack IPCs

PR4048 / PR4148	98
PR4049 / PR4149	99
PR4050 / PR4150	100

Industrial Monitors

MH/MHR100 / MQ/MQR100	104
MH/MHR200 / MQ/MQR200 <i>new</i>	106
MV100/MV200 - MVR100/MVR200 <i>new</i>	108
MK100 / MKR100	110
MK200 / MKR200 <i>new</i>	112
MX200 / MXR200 <i>new</i>	114

Configurations & Options

Video remotation solutions	117
Fieldbus boards	118
Wireless modules	119
UPS integrated in IPCs	120
Front Panels	122
Configurable button area for Arm Mounting IPCs and Monitors	124
Mechanical accessories for VK and MK systems	126

Technical support and service	129
--------------------------------------	-----

MORE THAN 40 YEARS OF INNOVATION MADE IN ITALY



Since 1979, ASEM is a pioneer in the digital technology integrations between Information & Communication Technology and Industrial Automation. The performance, configurability, robustness, design and the high number of software features of ASEM products and systems, are the result of 40 years of experience in designing and producing solutions for the most demanding industrial applications. Exploring from the very

SOLUTIONS FOR THE OPEN AUTOMATION

Thanks to a constant focus on innovation and quality, combined with investments in human resources, technology and manufacturing assets, ASEM is one of the European emerging companies in the industrial automation market, providing systems and solutions that are entirely designed, engineered and produced in-house. The company has been committed to anticipate customers' needs, convinced that machine builders should leave proprietary technologies, to embrace "Open & Standard" platforms, focusing on software application development. The integration of Information & Communication Technologies understood as an advanced, universal and non-proprietary digital system into machineries is now a need and it is no longer conceivable producing automatic machines that cannot be integrated into larger and more complex computer networks in which data and information can be

beginning the potential of Open & Standard technologies into Factory Automation, and leveraging the first-class know-how in developing hardware, firmware and software, ASEM has strengthened its leading position in Italy in the Industrial PCs, HMIs, remote assistance and control systems market.

shared. In Industry 4.0, digitalization and connectivity, together with a constantly changing demand for production and adaptability to the customised requirements of end users, find strong applicability in the concepts of smart factories, increasingly fast time-to-market, modelling and simulation of the entire production process. The revolution we are currently experiencing represents the transition from the paradigm of centralised to decentralised production enabled by technological evolution, which has overturned the conventional logic of production, with smart machines and/or objects that communicate and manage processes independently, interacting with the real and virtual worlds.

LEADING THE INDUSTRY 4.0 REVOLUTION

ASEM has long been a leading player in Italy in the Industry 4.0 and it is now one of the few medium European companies, if not the only one, able of mastering on its own all driver technologies of the current 4th Industrial Revolution, from x86 (PC) and ARM hardware platforms, to the most widespread operating systems, to the most advanced software and communication technologies for the development of its own HMI and remote assistance platforms, data acquisition from the field (Industrial IoT) and their storage and management on databases cloud based, as well as having the skills and full knowledge of control platforms based on SoftPLC and SoftMotion. Designing UBIQUITY, an Internet-based software solution providing remote access to automated machines and plants, ASEM was one of the first companies understanding the value of Information and

Communication Technologies applied to the Automation. In fact, ASEM was the first manufacturer that has integrated a remote assistance solution in operator panels, PACs systems based on ARM architecture, and later also in IPCs. The initiative, highly appreciated by the market, has allowed ASEM to create a new standard in Italy and Europe to which all competitors have adapted or are adapting. In 2013 ASEM also decided to face the most important multi-year investment in its history with the development of UNIQO, the cross-platform software platform "Full OPC UA" for the development of modern and responsive HMI and Industry 4.0 solutions.

VISION

Constantly innovating Factory Automation by combining the latest IT and automation technologies to provide "Open & Standard" technologies that simplify programming, monitoring and information exchange between machines, plants, and factories.



ASEM A ROCKWELL AUTOMATION COMPANY

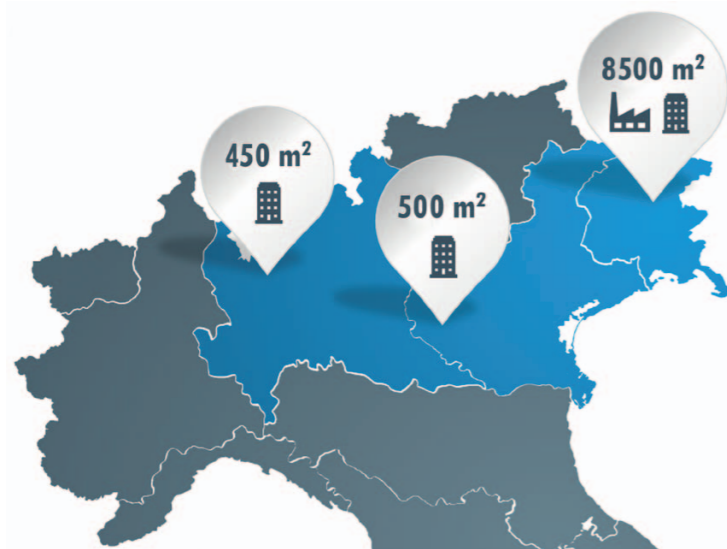

- 200 + employees** in 3 locations
30% dedicated to R&D
- ASEM Artegnà - Headquarters**
Hardware/Software R&D
System assembling
Testing e Warehouse
Sales and Finance
Accounting and Control
After Sales Services
Board & System assembling
Testing
Warehouse
- ASEM Verona**
Software R&D
Sales
- ASEM Giussano**
Software & System assembling
Software & System Support
Sales

CONTINUITY IN TECHNOLOGICAL IDENTITY, FLEXIBILITY AND SALES APPROACH IN A GLOBAL CONTEXT

On April 30th 2020 100% of the ASEM shares were acquired by Rockwell Automation S.r.l., a company belonging to the American group Rockwell Automation Inc., primary player operating in the industrial automation sector with headquarters in Milwaukee, Wisconsin (USA), with over 23,500 employees worldwide, customers in over 100 countries and a 2020 turnover of 6,3 billion US Dollars. Given the complementarity in terms of products / systems and

in terms of commercial approach, ASEM will have the opportunity to grow faster and spread its products and solutions all over the world through the global network of the Rockwell Automation group. Within the group, all synergy possibilities will be deepened and implemented, and in addition to supplying its products in brand-label to Rockwell Automation, ASEM will continue operating in the market independently, with its own team, its management and its sales organization in Italy

and abroad, keeping in absolute continuity the characteristics that you appreciated until today, such as flexibility, a wide range of configurable and customizable products / systems and software solutions based on "Open & Standard" technologies, fast delivery times and after-sales support.

ASEM WITH ROCKWELL AUTOMATION. FROM LOCAL NETWORK TO GLOBAL NETWORK



Rockwell Automation connect the imaginations of people with the potential of technology to expand what is humanly possible, making the world more productive and more sustainable.

MILESTONES

SPECIALIZING IN ELECTRONIC ENGINEERING

Founded in 1979 by Renzo Guerra, ASEM (Automazione Sistemi Elettronici Microcomputer) started as an engineering company designing and producing microprocessor-based industrial automation systems.

1979
1982



PLAYER OF THE IT WORLD

ASEM enters the IT market by designing and manufacturing interfaces and accessories for Personal Computers. As the only Italian company besides Olivetti®, ASEM manufactures MS-DOS compatible PCs, gaining in the latest 80's the 6% of the Italian PC market, more than global companies like Apple® and Compaq®.

1983
1992



LEADING THE INDUSTRIAL PC MARKET

In the mid-90's, ASEM is the first company in Italy focused on the design and production of Industrial PCs, addressing the industrial automation market.

1993
2005



2006
2008



PRODUCING AUTOMATION SYSTEMS

In 2006, ASEM begins a specialization path to approach the market not only as a manufacturer of Industrial PCs, but as a company providing automation systems with software. Thanks to agreements with partners ASEM offers Premium HMI and CODESYS (softPLC) software platforms. ASEM opens an office in Giussano (MB) dedicated to software and system support.



ASEM A ROCKWELL AUTOMATION COMPANY

In April 2020, Rockwell Automation, a world leader in automation and control solutions, formalised the acquisition of ASEM in order to strengthen its product portfolio.



THE 4.0 HMI REVOLUTION IS A REALITY

ASEM releases the revolutionary UNIQO software platform, developed with cross-platform technologies compatible with ARM and x86 architectures and with Windows and Linux operating systems, always guaranteeing maximum performance. UNIQO fully supports the specification of the OPC UA standard and for this reason, it can be defined as a software platform "FULL OPC UA", for the development of modern, responsive HMI and Industry 4.0 solutions.

OPC UA IN THE PREMIUM HMIS® PLATFORM

ASEM releases the new Premium HMI 5 visualization software version, including multitouch programming, support for multicore processors and OPC UA protocol leading the way to the distributed connectivity of the "Industry 4.0" and Industrial "IoT".

2011
2012



THE ERA OF SOFTWARE AND REMOTE ASSISTANCE

ASEM releases Premium HMI 3, the first visualization software with new features developed in-house. The company introduces the remote assistance platform UBIQUNITY to remotely access automation devices via VPN. ASEM opens a second manufacturing facility dedicated to assembly and test of electronic boards and systems. ASEM opens a local software R&D office in Verona. ASEM starts designing and producing ARM-based HMIs, remote assistance and PAC systems.

2010

EXPANSION IN EUROPE

ASEM approaches the foreign market with the promotion and sales of products and software solutions in the European market.

2020

2019

2016

THE SEAMLESS INTEGRATION OF HARDWARE AND SOFTWARE TECHNOLOGIES IS KEY TO SUCCESS

30% of ASEM human resources are dedicated to R&D. The team includes highly specialized engineers with complementary skills that cover all the electronic and mechanical design needs, as well as firmware and software development. The close collaboration with leading technology trendsetters and the continuous dialogue with customers drive the specifications of hardware, firmware, software and systems engineering for each single product. Thanks to the technological mastery of all system components and their perfect integration, ASEM designs performant, configurable, easy-to-use and reliable products for the most demanding industrial

environments. The different R&D teams work in synergy during the design process to ensure that hardware requirements and software features of each solution can be implemented in an integrated way. The long experience and the high skills of the R&D engineers make ASEM a reliable technological partner to support machine builders and system integrators in the fast-changing industrial automation market.

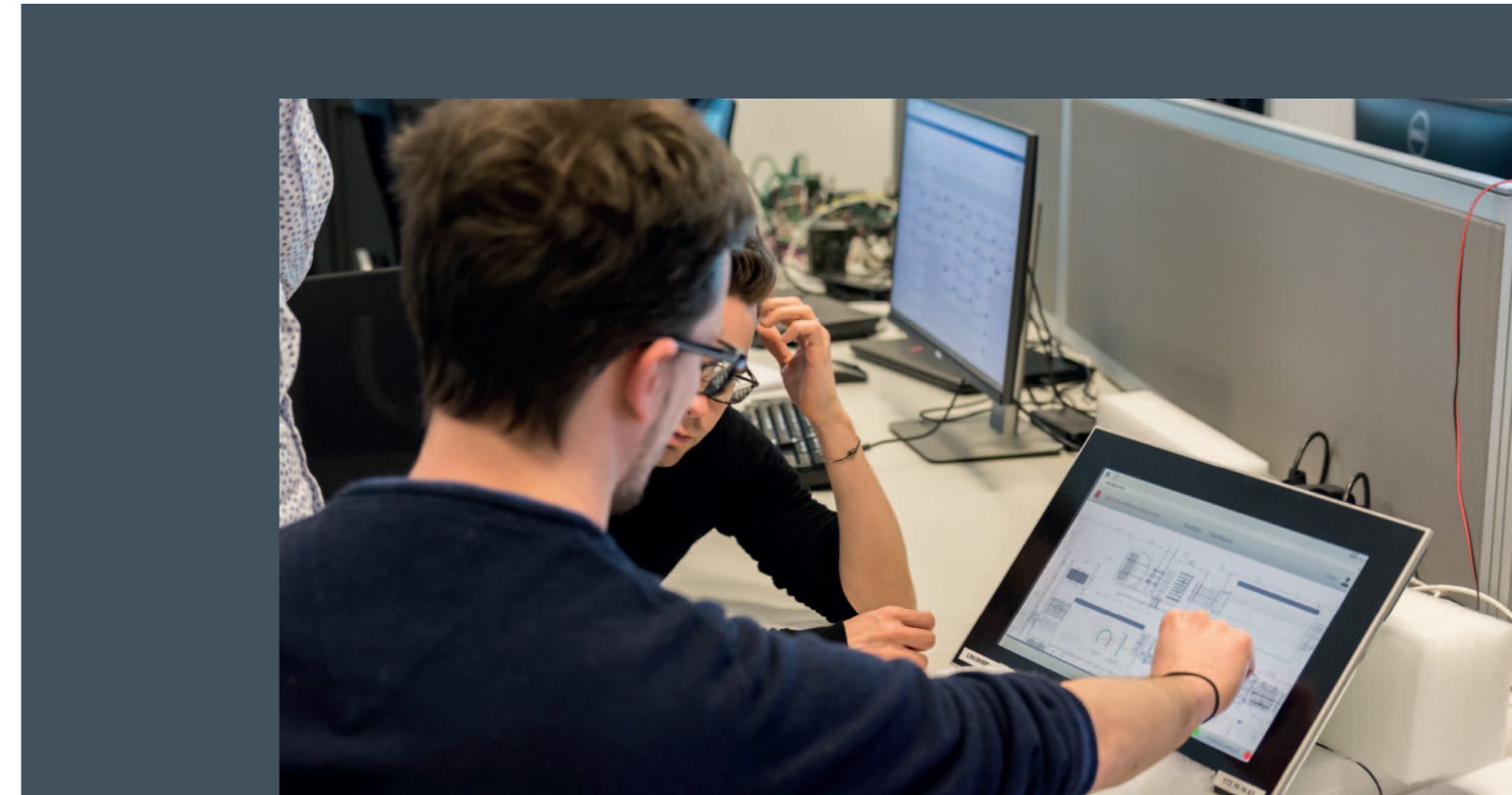
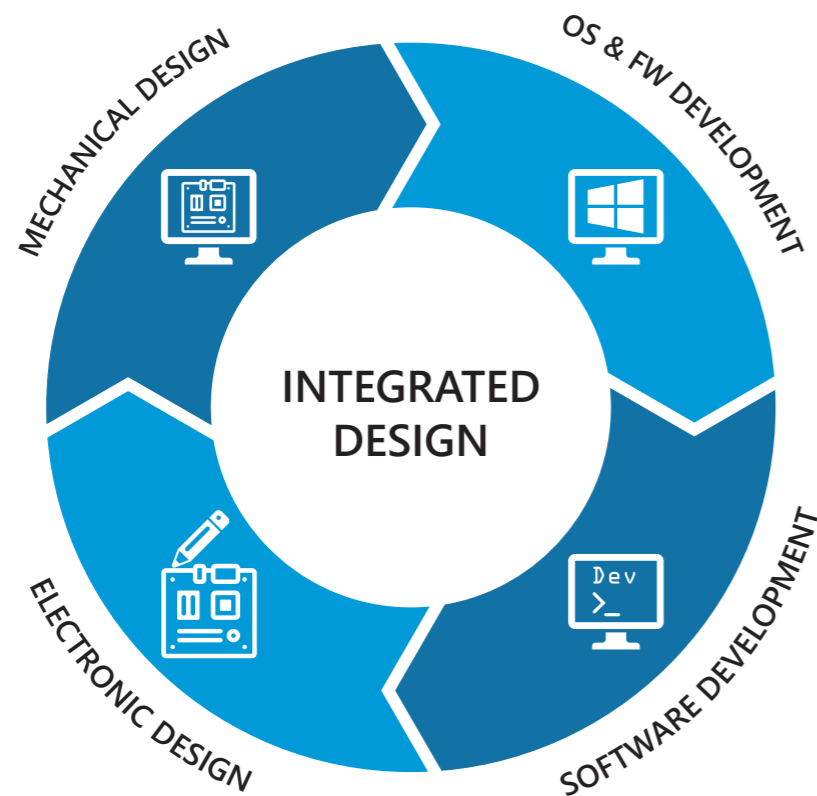

R&D SKILLS - HARDWARE, FIRMWARE AND OS IMAGES

MECHANICAL DESIGN

- 3D modeling and assembling simulation and mechanical couplings
- Analysis and thermal simulations for dissipation dimensioning
- Connected mechanics and electronics CAD for integrated engineering
- Close cooperation with the mechanical parts manufacturers
- Complete know how for each mechanical detail and production phase
- Easily customizable mechanical design

ELECTRONIC DESIGN

- Design of:
- Intel x86 based boards
- NXP ARM based boards
- Creation of PCB masters
- Internal EMC testing
- PCB design
- Signal integrity test through CAD simulation
- In-house laboratory for EMC compatibility testing

OPERATING SYSTEMS AND FIRMWARE DEVELOPMENT

- IPC Operating system engineering, testing and customization (Windows and Linux)
- Development, customisation and testing of BSPs for ARM platforms (Windows CE and Linux)
- IPC device drivers development and testing
- IPC BIOS development and testing
- Real time system configuration and testing
- CODESYS SoftPLC device drivers and libraries development

AGILE SOFTWARE DEVELOPMENT

- Automatic testing at all levels (Unit, Component, Integration, API, GUI)
- Automatic update of the latest released versions on dedicated websites with changelog and help
- Use of pair programming and coding standards
- Test driven development (TDD)
- Continuous Integration (CI)
- Frequent feature release on the market
- Kanban board for planning activities
- Eliminate waste and optimize processes

HIGH QUALITY PRODUCTION

ASEM manufacturing plants comprise two modern industrial facilities covering a total area of 8.500 sqm. ASEM designs, engineers and manufactures electronic boards, products and systems internally. The decision to assemble electronic boards in its own Italian facility is in contrast with the industry trend to relocate electronics production activities in Eastern Europe and Far East, but the results in terms of quality and in terms of flexibility confirm the accuracy of the company's strategic decision, much appreciated by customers.



BOARD ASSEMBLY

The in-house assembly of electronic boards and a constant dialogue between operations' managers and the R&D engineers increase the sensitivity of electronics and mechanical designers towards production and test phases, with a consequent advantage of an increased reliability of the overall system. The electronic components are supplied by the major global manufacturers and are specifically selected to ensure a long life cycle of products. Mechanical parts are purchased from European suppliers selected with rigorous qualification procedures.

- Admitting and warehouse control (Kardex)
- B.O.M. (Component Selection & Management)
- Pick & Place machine programming
- 3 complete SMT lines
- Pick & Place
- Re-melting furnaces (Ersa)
- Screen printers with integrated Post Print AOI (Ersa)
- Selective soldering machine for "Through Hole" technology
- Visual board inspection
- X-Ray Inspection
- Functional Tests
- Bed-of-nails board supply voltage test
- Functional testing of boards for eight hours (3 cycles)
- Active burn-in test (0°- 50° / 24H cycles)

SYSTEM ASSEMBLY

- B.O.M. (Component Selection & Management)
- System assembly (mechanical and electronic)
- Imaging of the operating system on mass storage
- Full functional test of final system
- Run-in TEST (8H)
- Final Control & Packaging

LONG-TERM AVAILABILITY

The full control of design and production processes and the close cooperation with technology trendsetters allow ASEM to ensure a 7/10 years life cycle of its systems and reparability of the same for at least 5 further years, with availability of spare parts. ASEM guarantees End of Life procedures lasting from 6 to 12 months for the Last Buy Order and deliveries.

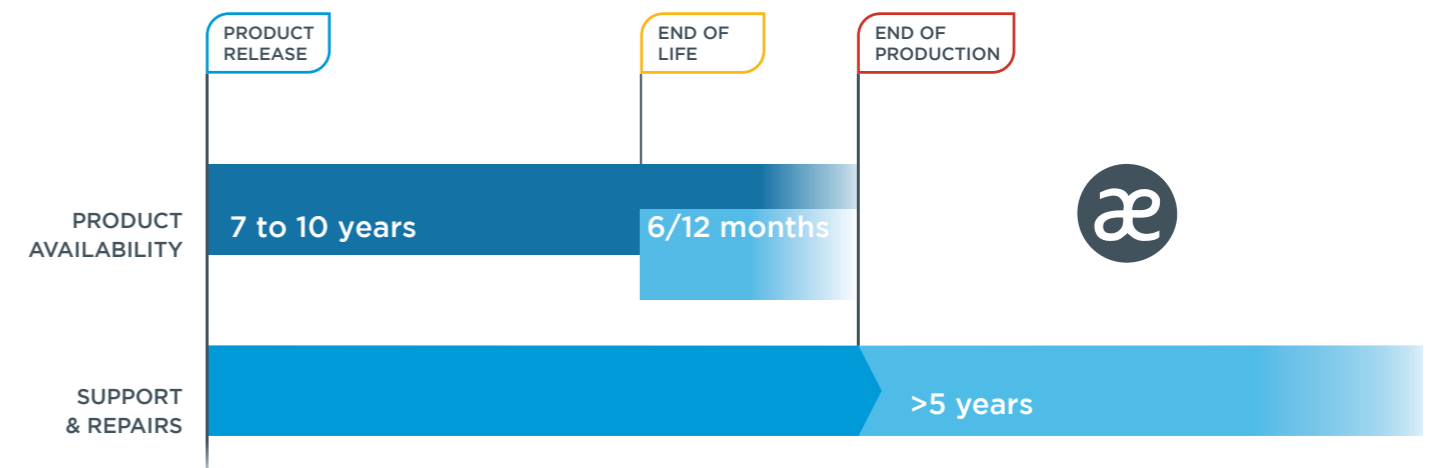

SOLUTIONS FOR A CONNECTED AND SMART FACTORY

ASEM designs and manufactures innovative and flexible solutions that enable the transformation of industrial plants into connected and Smart Factories, successfully meeting the challenges posed by the on going revolution. The use of Open & Standard, ARM and x86 technologies integrated with flexible and easy-to-use software development tools ensure maximum flexibility in the implementation of distributed automation architecture.

ASEM provides:

- Complete IPC portfolio and ARM embedded systems available in all form factor, high-performance, configurable and expandable to meet the needs of each application in the industrial automation field
- Visualisation systems based on innovative software UNIQO and Premium HMI, for the development of modern, responsive, ergonomic and intuitive interfaces, conforming to the OPC UA standard and suitable for any automation device, significantly reducing development time
- Web Panel for HMI applications based on web thin clients
- Control systems based on the SoftPLC CODESYS, the modular, object-oriented, flexible development tool with which automation projects can be realised using IEC 61131 programming languages and support from real-time simulations. The systems are equipped with 512kB of MRAM for saving the retentive variables and microtamping system in case of a power failure

- Remote assistance solutions based on UBIQUITY, the software platform that enables the access to remote supervision and control systems (PLCs, inverters (PLCs, inverters, drives, etc.) through a VPN optimised for industrial communications. UBIQUITY is included in all HMIs, PACs and IPCs with Microsoft Windows O.S. Nowadays UBIQUITY is one of the most complete and tested solutions in terms of architecture and functionality. It is also available as all-in-one router version
- IIoT Gateway for data collecting and sending them to public or private cloud infrastructures also available with integrated UBIQUITY remote assistance software
- Robust, reliable and well refined design industrial monitors, also with integrated RVL technology for the remotation of DVI-D and 2.0 USB signals

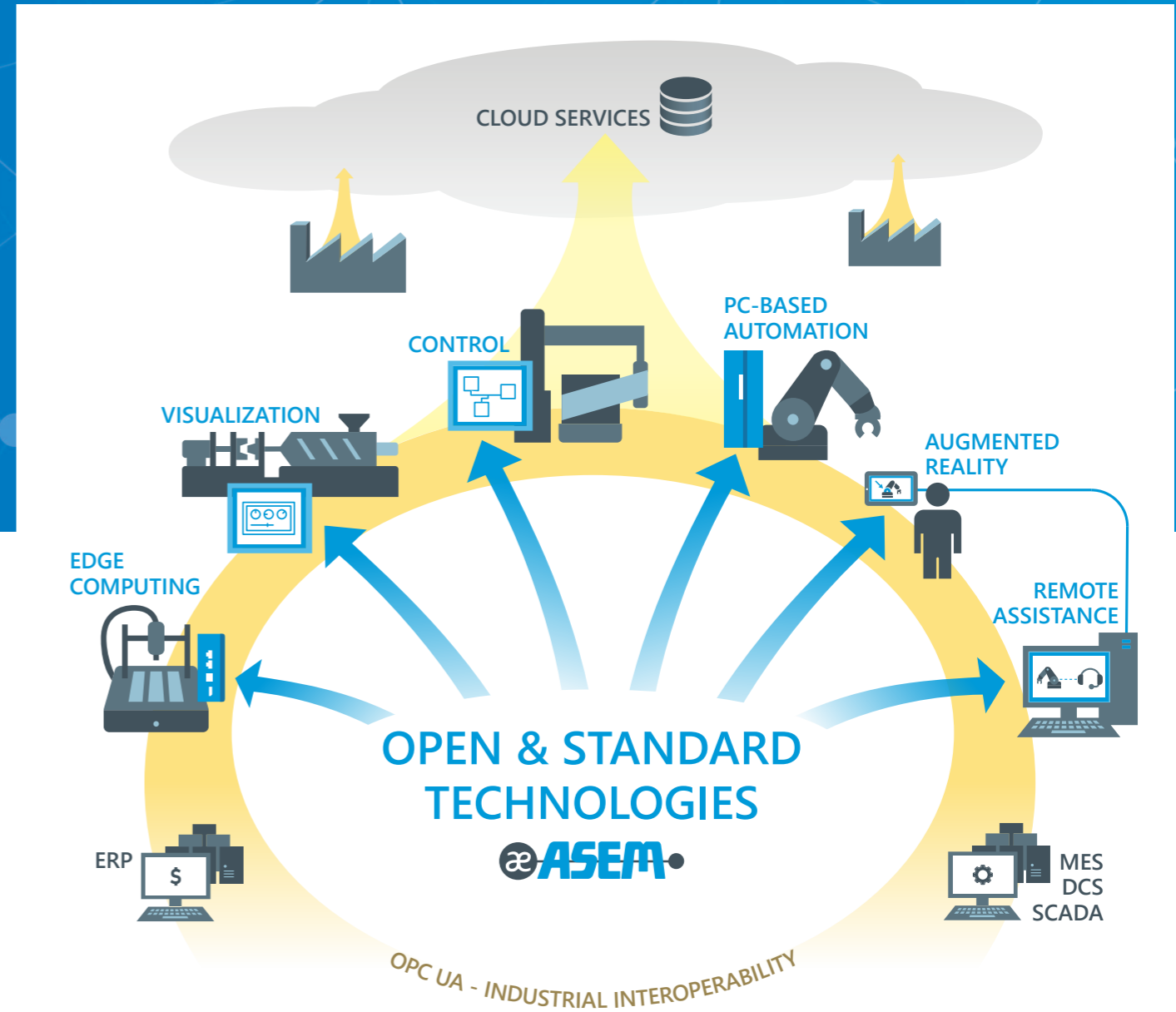

ASEM's integrated systems enable factories to become smart and adapt themselves to changing operating conditions and to sudden changes in planning. ASEM systems allow to:

- Collecting and monitoring production data thanks to full compatibility with the most popular fieldbus protocols and the OPC UA standard
- Sharing data within the factory (M2M, MES) through internet connectivity (also wireless)

- Processing data and optimising production processes at the edge of the network (Edge Computing)
- Cloud connection through IIoT Gateway for storing and sending data collected and processed, managing communication interruptions (store and forward) and bidirectional communication between the cloud and the field system.

Industrial PC Solutions

ASEM IPCs
The only IPCs
with remote assistance
solution integrated



Industrial PC & Monitor features



More than 25 years of Industrial PCs

The "x86" (PC) and ARM Cortex platform technologies represent the evolution towards open and standard platforms, replacing systems based on proprietary technology. These "Open & Standard" technologies are driving the process of technological convergence and digital

integration between ICT (Information and Communications Technology) and Industrial Automation. Since the 80's ASEM has been designing x86 technology and since more than 20 years has been leading the "Open Automation" in Italy designing, engineering and manufacturing "Open & Standard" systems for the Industrial Automation market.



A complete product range

To satisfy different market needs, ASEM offers a wide range of industrial PCs including Panel IPCs with LCDs from 4.3" to 24" in 4:3

and Wide 16:9 aspect ratios, Arm Mounting IPCs with 15.6", 18.5", 21.5" and 24" Wide LCDs, Box IPCs with wall or DIN rail mounting and a complete range of Industrial

Panel Monitors with LCDs from 8.4" to 24" in 4:3 and 16:9 aspect ratios and Arm Mounting Monitors with LCDs from 15.6" to 24" in 16:9 aspect ratio.



Quality, reliability and performances

The mastery of hardware, firmware and system technologies and the long experience in mechanical design and engineering

have enabled ASEM to manufacture high quality and extremely reliable Industrial PCs and Monitors with strong attention to details and excellent value for money.

The expertise on heat dissipation methods has allowed ASEM to manufacture fanless systems integrating high performance and high power consumption quad core processors.



Chassis and Front Panels

Over the years, ASEM has gained considerable experience on materials and surface treatments to ensure electrical conductivity, shielding optimization and protection from external agents to its industrial PCs and monitors' chassis. Chassis are made of galvanized

steel or casted aluminium and are the result of an industrialization based on thermodynamic and fluid dynamic analysis aimed at a seamless integration of electronic boards and mechanical components. To meet the specific needs of food, chemical and pharmaceutical industries, some systems are designed and manufactured with stainless steel frames and chassis. One of the most important

details of Panel IPCs and Monitors are the front panels, designed to meet aesthetic, ergonomic and robustness requirements and at the same time ensure a protection grade up to IP69K or, with USB interfaces on the front, up to IP66. The ASEM standards include four front panel variants for Panel IPCs and monitors: Aluminium with resistive touchscreen, True Flat Aluminium with resistive

touchscreen, Stainless Steel True Flat with resistive touchscreen and Aluminium True Flat with glass projected capacitive (P-CAP) Multi-touchscreen. Furthermore, for Aluminium and Aluminium True Flat Multitouch front panels, two new versions with minimized frame are available, in order to reduce encumbrance and improve aesthetic results.



Interchangeability and continuity

With a product life cycle of at least 7/10 years, ASEM designs Panel IPCs and monitors with the same cut-out (hole size needed for the installation) for each different LCD size to ensure interchangeability, without mechanical changes, among different families and compatibility with future families allowing to upgrade the Panel IPC or monitor even on machines on the field since many years.



UPS and Power Supply Systems

To prevent noise and overvoltage, IPCs and monitors' power supplies have galvanic isolation. Industrial PCs based on x86 processors have the option to integrate on the power supply unit the UPS (Uninterruptible Power Supply) function with an external battery pack. The ARM based systems can integrate the MicroUPS function with supercapacitors.



Motherboards

The IPC's motherboards have microprocessors included in Intel® embedded roadmap, with a long life cycle guaranteed by the manufacturer. ASEM motherboards use different platform technologies with scalable

performances, from entry-level processors in terms of price up to high performance dual and quad core processors, providing different expandability in terms of communication interfaces and expansion slots. Currently, ASEM portfolio includes the latest generation Intel® Apollo Lake™ platform, with dual and quad core Atom E39xx processors, the Intel® Bay Trail™ platform, with quad core J1900 Celeron processor, the 6th and 7th generation Intel® Core™ microprocessors Skylake™ H/U and Kaby

Lake™ series and ARM-based systems equipped with dual and quad core iMX6 processors. Motherboards are designed to provide "all-in-one" integration of every possible function (for instance the touchscreen controller) and minimize cables and connectors in order to make systems more resistant to possible vibrations and shocks in industrial environments. 100% of the motherboards are subject to burn-in and functional tests, for 12 consecutive hours, in

dedicated climate chambers. All motherboards feature the ASEM System Identity, a non-volatile storage for system identification data, as well as other useful customers' data for system traceability. One of the R&D teams is dedicated to BIOS and low level driver development for x86 platforms and to BSP (Board Support Package), boot loader and low-level drivers development for ARM Cortex platforms.



Operating Systems

Depending on microprocessor platform, ASEM ensures full compatibility of x86 systems with Win 32/64 Standard/ Embedded and Windows Embedded Compact 7 Pro operating systems and full

compatibility with the most popular Linux distributions. ARM Cortex A8 and A9 platforms support Windows Embedded Compact 7 Pro and Linux distributions assembled by ASEM. ASEM specialists can also

give support to implement a custom made image or develop customized embedded Win 32/64 and Linux images on specific customers request.



Fieldbuses

All x86 systems released by ASEM have the possibility to install fieldbuses (NETcore X)

boards, Master and Slave versions, that support the most spread industrial fieldbuses such as EtherCAT,

CANopen, Profibus, Profinet, MODBUS and EtherNet / IP.



Systems testing and certification

100% of the electronic boards are subject to burn-in and functional tests at a temperature range from 0° to 50° C for a minimum of 12 hours in special designed climatic chambers. All ASEM products are

compliant with EMC directives for emissions and immunity, the low voltage directive and the RoHS directive. Most products and systems are comply with UL certification and specific products are compliant with the ATEX directive.

Custom Solutions

The complete control of hardware, firmware and software technologies allows ASEM to realize custom systems for specific customer needs.



Light custom Solutions

Custom-light services provide different levels of customization of ASEM standard products:

Aesthetic light custom, such as:
 → removal or substitution of the ASEM trademark with a label showing the brand and/or logo of the customer;
 → customization of front film with silkscreen printing of client brands and/or logotype;

Mechanical light custom, such as:
 → personalization of the shape and / or thickness of the front panel;
 → Customization of the layout of the keyboard on the front panel;

Electronic light custom, such as:
 → addition of communication interfaces and / or modification of the standard configuration.

The customizations described do not involve any structural changes to standard products and meet the typical needs of OEMs and System Integrators who want to offer their own solutions to the market with a homogeneous representation of the brand. Custom-light solutions can be made in a relatively short time and low volume production.



Full custom solutions

Custom-full services include the creation of new platforms and solutions based on customer specifications. ASEM does not normally sell the intellectual property of custom projects, as their realization is solely dedicated to ASEM serial production. Custom full services include the following development activities:

Mechanical custom-full, such as:
 → creation of a new mechanical solution, also with plastic parts, that uses existing electronic cards and/or motherboards;

Electronic custom full, such as:
 → development of new motherboards and/or electronic cards;

Complete custom-full, such as:
 → development of a new system or solution that includes the design of mechanical components as well as electronic boards.

ASEM Standards

ASEM has set the electronic and mechanical design standards for Panel IPC, Box IPC and Monitor families to guarantee maximum flexibility, higher safety and continuity to customers.

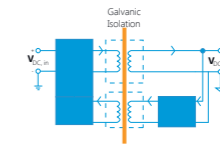

Power supply with galvanic isolation

To prevent:
 → Common mode noise at low/medium frequencies on the power supply line
 → Ground loop noise
 → Extra-voltage caused by lightning
 And guarantee:
 → Power supply with grounded positive terminal (e.g. Japan)



Power supply with integrated UPS (uninterruptible power supply)

→ With external battery pack on the back of the system
 → With external standalone wall mounting battery pack

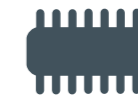

ASEM system identity

→ Non-volatile memory for system identification data storage

Specific standards for HT and MH/MHR families



Front panel available in four different variants

→ Aluminium with USB port
 → True Flat Aluminium with USB port
 → Stainless Steel True Flat
 → True Flat Aluminium with glass projected capacitive Multitouch screen



Cut-Out

A single cut-out for every LCD size to ensure interchangeability among HT panel IPCs families and the MH/MHR monitors family

Four variants of the front panel



Aluminium with USB

True Flat Aluminium with USB port

True Flat Stainless Steel

P-CAP Multitouch Glass and Aluminium

Specific standards for QT and MQ families



Front panel available in two variants
 → Aluminium with resistive touchscreen
 → True Flat aluminium and glass with projected capacitive Multitouch screen



Cut-Out
 A single cut-out for every LCD size to ensure interchangeability among QT panel IPCs families, the MQ/MQR monitors family and HMI Q, LP Q and RT Q ARM based families.

Two variants of the front panel



Aluminium



Aluminium & glass P-CAP Multitouch

Cut-out standard

The following grid includes the measures of the three different cut-out sets: "A" Cut-Out refers to ARM based HMIs, LPs and RTs; "HT" Cut-Out refers to panel IPC families HT, panel x86 PAC families LP and the industrial monitor family MH/MHR; the new "QT" Cut-Out refers to ARM based HMI Q, LP Q and RT Q families, to panel IPC families QT, panel x86 PAC families LP Q and the industrial monitor family MQ/MQR.

	Ratio	"A" Cut-Out		"HT" Cut-Out		"QT" Cut-Out	
		L	H	L	H	L	H
4.3"	16:9	131	86	-	-	-	-
5.7"	4:3	164	134	-	-	-	-
6.5"	4:3	-	-	192	167	-	-
7" A	15:10	204	144	207	159	-	-
7" B	15:10	197	140.5	197	141	197	141
8.4"	4:3	243	179	230	190	-	-
10.1"	16:10	285	193.5	277	196	256	174
10.4"	4:3	283	219	280	225	-	-
12.1"	4:3	313	249	315	250	-	-
12.1"	16:10	313	215	315	218	301	203
15"	4:3	378	294	370	295	-	-
15.6"	16:9	410	255	410	255	388	238
17"	5:4	-	-	435	335	-	-
18.5"	16:9	-	-	480	300	453	275
19"	5:4	-	-	470	368	-	-
21.5"	16:9	-	-	559	347	520	312
24"	16:9	-	-	620	382	576	345

Software solutions for the industrial automation

Remote Assistance: UBIQUITY



In 2011 ASEM presented UBIQUITY, the innovative software platform for remote assistance. Designed for machine builders, the remote assistance solution UBIQUITY enables access to remote systems and their sub-networks as if they were connected with a cable. The software solution UBIQUITY enables the access to remote supervision and control systems and to the automation devices (PLC,

drive, etc), connected to the **Ethernet and Serial subnetworks** of the IPC/operator terminal/controller, through a VPN (Virtual Private Network) based on **proprietary technology optimized for industrial communication.** UBIQUITY does not require additional hardware and allows to operate in remote plants as if they were directly connected to your enterprise network.

It enables **technical support teams to solve any issue**, eliminating the need for on-site assistance, dramatically **reducing post-sale service costs.** This solution is particularly useful during machine setup and commissioning, to monitor remote applications, to modify and update software applications and remotely debug PLCs and other automation devices.



Starting from March 2016, UBIQUITY is installed on all ASEM IPCs, enhancing the value of every IPC with an integrated remote assistance solution.

Control: CODESYS



ASEM Programmable Automation Controllers base their **PLC functionalities** on the consolidated and widespread CODESYS SoftPLC of the German 3S, with a highly

efficient implementation of version 3.5 which guarantees the **deterministic execution of PLC control logic** with WinCE and Win 32/64 operating systems.

CODESYS let the projects to be transferred between various operating systems and hardware platforms without the need to change the project code.

Visualization and Industry 4.0: UNIQO HMI



The UNIQO HMI platform is based on cross-platform technologies, allowing cross-sectional applications on Windows and Linux operating systems. Also Android and iOS mobile operating systems will be supported in future, which run on x86 or ARM based hardware, always ensuring top performance. UNIQO HMI fully supports the OPC UA standard specification, that allows to create dynamic client/server architectures, in which HMI systems alternately take the role of generator and user of a large range of information. In fact, with UNIQO HMI OPC UA can be used to acquire field data, for horizontal information exchange between machine and machine, for interfacing with MES/ERP business management systems and for interfacing with the cloud.

On a UNIQO HMI based system it is possible to share not only data, but also applications functionalities allowing an external OPC UA client to actively interact with all the project functions, such as user authorizations, recipes or even graphic resources of the screens.

UNIQO HMI projects are totally dynamic since everything that can be done at design time with the "Q STUDIO" environment, can also be done at runtime through default commands and/or through application logics written in C#. The "Q STUDIO" design environment also supports a so-called "Connected-Mode" function, that allows to connect to a running HMI, download the project and apply changes in "live", without arresting HMI operations. The changes made to the project are immediately updated, with no need for cost intensive machine stop or cumbersome redesign of the project. They are saved with a sophisticated mechanism that allows at any time to turn back to previous conditions in complete safety.

With UNIQO HMI it is possible to create responsive interfaces with innovative graphic design tools that take advantage of the "container" concept, allowing to automatically arrange the objects inside in rows, columns, matrices, with full support to the gestures of multitouch interface. In UNIQO HMI, everything that is designed becomes an object, with immediate advantages in terms of modularity and reusability of applications that were developed according to these criteria.

Visualization: Premium HMI and PHMI Mobile



With Premium HMI software platform, ASEM has been providing valuable visualization systems appreciated for the **quantity and quality of the functionalities** available and the **transversality** of the platform, which makes it possible to use the same project both on HMI

solutions based on ARM or x86 hardware platforms (also with multicore architecture support), with WinCE or Win 32/64 Runtimes without any need to modify or change settings in the 'Premium HMI Studio' development tool.

Multitouch and OPC UA Premium HMI 5 supports Multitouch programming for Win 32/64 and WEC 7 systems with multicore processors and supports OPC UA protocol, leading the way to the distributed connectivity of the "Industry 4.0" and Industrial "IoT".

Premium HMI Mobile is the App to view and interact with Premium HMI projects, via mobile devices (iOS and Android) connected to the enterprise Wi-Fi network. The new app provides mobile and multitouch support to the HMI project running on Machine Operator Panels/ Panel IPCs.

Industrial IoT: IIoT Cloud Connector



IIoT Cloud Connector is the software solution specifically designed to **securely publish relevant field data on cloud**

databases for later analysis. IIoT Cloud Connector comes as an optional service of the ASEM HMI software

Premium HMI to extend the datalogging capabilities by easily interfacing with the cloud storage technology,

aiming to provide a secure and **effective solution to the modern IIoT and Industry 4.0** application scenarios.

Product Portfolio

1. ARM based panel

The ARM based Panels, with Cortex A8 and A9 processors, are available with Microsoft Windows Embedded Compact 7 Pro or Linux operating systems. They include a wide range of 16 million colours TFT LED Backlight LCD screens, from 4.3" up to 18.5" with resistive touchscreen and Aluminium/True Flat Aluminium front Panels and True Flat Aluminium with glass projected capacitive Multitouch screen.

RT25  p. 23	RT30  p. 24	RT35/RT35Q  p. 26	RT40 / RT40Q  p. 28
--	--	---	--

2. Panel IPCs

ASEM Panel IPCs are low consumption and high computing performance systems, with or without fans, based on Celeron and Core™ i3, i5, i7 dual and quad core processors. Available with TFT LCDs from 6.5" to 24" and aluminium, True Flat aluminium, True Flat stainless steel front panels and resistive touchscreen or True Flat aluminium front panels with glass projected capacitive Multitouch screen.

HT2150 / QT2150  p. 32	HT2200 / QT2200  p. 34	HT2250 / QT2250  p. 36 new	HT3200 / QT3200  p. 38
HT3500 / QT3500  p. 40 new	HT3400/3600 / QT3400/3600  p. 42	HT5400/5600 / QT5400/5600  p. 44 new	

3. Book Mounting IPCs

ASEM recently completed its Box IPC portfolio with a complete range of book mounting systems, combining performances, design, ergonomics and configurability. Based on ARM Cortex A9 or Intel® Apollo Lake™, Bay Trail™, Skylake™ and Kaby Lake™ platforms, they are supplied with a sturdy aluminium or plastic chassis, highly refined in every aesthetic and ergonomic detail.

BM40  p. 48	BM100 / BM110 / BM120 / BM121 / BM122 / BM130 / BM131  p. 50 new	BM2150  p. 56	
BM2200  p. 58	BM2250  p. 60 new	BM3300 / BM3500  p. 62	BM3400 / BM3600  p. 64

4. Box IPCs

ASEM provides a full range of Box IPCs based on Celeron, Core™ i3, i5, i7 dual and quad core processors of the Intel® Bay Trail™, Broadwell™, Skylake™ and Kaby Lake™ platforms, and they are suitable for wall or DIN rail mounting.

PB2150  p. 68	PB2200  p. 70	PB2250  p. 72 new	PB3200  p. 74
PB3500  p. 76 new	PB3400 / PB3600  p. 78	PB5400 / PB5600  p. 80 new	

5. Arm Mounting IPCs

The Arm Mounting IPCs are compact, fanless, ergonomic and easy to install systems with a stylish design, that are easy to install and compatible with the most common mounting standards. Based on Intel® Bay Trail™ platform with 15" TFT LCD or Intel® Broadwell™ platform available with 15.6", 18.5", 21.5" and 24" TFT LED Backlight LCDs in a Full IP65 aluminium chassis.

VK3200  p. 84	VK3500  p. 86 new	VPC2200  p. 88
--	---	---

6. Rack IPCs

19" 4U rack solutions with a wide range of configurations, motherboards, expansion slots and Intel® Xeon™ and Core™ i3, i5, i7 dual, quad and exa core processors up to Intel® Coffee Lake™ platform.

PR4048 / PR4148  p. 92	PR4049 / PR4149  p. 93	PR4050 / PR4150  p. 94
---	---	---

7. Industrial Monitors

The panel Industrial Monitors are available with LCDs from 8.4" to 24", with 4:3, 5:4 or Wide format, and four front panel variants. Arm Mounting Monitors are compact, fanless, ergonomic and easy to install solutions, compatible with the most common mounting standards and are available with 15.6", 18.5", 21.5" and 24" TFT LCDs in a full IP65 aluminium chassis. MX200 features a stainless steel chassis and Full II IP69K protection grade. All the monitors are also available with integrated RVL technology which allows the transmission of DVI-D and USB 2.0 signals up to 100 meters.

MH/MHR100 / MQ/MQR100  p. 98	MH/MHR200 / MQ/MQR200  p. 100 new	MV100 / MVR100 / MV200 / MVR200  p. 102 - p.104 new
MK100 / MKR100  p. 106	MK200Q / MKR200Q  p. 108 new	MX200 / MXR200  p. 110 new

ARM based Panels

The ARM based Panels, with Cortex A8 and A9 processors, are available with Microsoft Windows Embedded Compact 7 Pro or Linux operating systems.

They include a wide range of 16 million colours TFT LED Backlight LCD screens, from 4.3" up to 18.5" with resistive touchscreen and Aluminium or True Flat Aluminium front Panels and True Flat Aluminium with glass projected capacitive Multitouch screen.



Panel ARM based



RT25

Entry level ARM based Panels



The ARM based Panel IPCs of the RT25 family have the smallest LCD sizes of the ASEM portfolio. They are based on the ARM Cortex A8 (i.MX535) 1GHz processor. The "all in one" motherboard provides one Ethernet 100Mbps port, one

USB 2.0 port, one serial RS232/422/485 interface with rear access, 1 GB DDR3 RAM, 256MB Nand-Flash for the operating system and 4GB pseudo-SLC eMMC memory to save and manage application and project data.

The RT25 family is available with 16 million colours LED Backlight TFT LCDs, 4.3" and 7" in Wide aspect ratio, with aluminium or aluminium True flat front panels and 4 wires resistive touchscreen. RT25 systems have a 24 VDC power supply input.



+ Highlights

- "All in one" motherboard
- Microsoft Windows Embedded Compact 7 Pro or Linux Yocto operating system
- ARM Cortex A8 processor (i.MX535)
- Fanless ARM based panel IPC with 0°C÷50°C operating temperature
- 4.3" and 7" LCDs in Wide aspect ratio
- 24 VDC power supply input
- CE, cULus LISTED (508) certifications

RT30

ARM Cortex A8 based panel from 5.7" to 15.6"W



The ARM based Panel IPC family RT30 is based on the ARM Cortex A8 1GHz/800MHz processor (i.MX535/i.MX537). The "all in one" motherboard provides one Ethernet 10/100Mbps port, one Ethernet 100Mbps port, two USB 2.0 ports, one serial RS232/422/485 interface with rear access, 1 GB DDR3 RAM, 256MB Nand-Flash for the operating system and the runtimes, 4GB pseudo-SLC

eMMC memory to save and manage application and project data and a removable SDHC memory slot. The RT30/31 family is available with 16 million colours LED Backlight TFT LCDs from 5.7" to 15.6", in 4:3 and Wide aspect ratio, with aluminium or aluminium True flat front panels and 4 or 5 wires resistive touchscreen. All version with Wide LCDs are also available with aluminium

and glass TrueFlat Capacitive front panels, with projected capacitive touchscreen. RT30/31 systems have a 24 VDC power supply input and optionally an integrated MicroUPS based on supercapacitors.



+ Highlights

- "All in one" motherboard
- Microsoft Windows Embedded Compact 7 Pro or Linux Yocto operating system
- ARM Cortex A8 processor (i.MX535/i.MX537)
- Fanless ARM based panel IPC with 0°C÷50°C operating temperature
- 5.7", 8.4", 10.4", 12.1" and 15" LCDs in 4:3 aspect ratio, 7", 10.1", 12.1" and 15.6" LCDs in Wide aspect ratio
- Integrated MicroUPS with supercapacitors (optional)
- CE, cULus LISTED (508) certifications
- ATEX area 2/22 certification (only RT30)

Technical Data

	RT25	RT25-TF	RT30	RT30-TF	RT30-TFC
O.S. AVAILABLE	Microsoft Windows Embedded Compact 7 Pro with Datalight Reliance Nitro file system Embedded Linux distribution based on Yocto Project				
LED backlight TFT LCD	4.3" W - 480x272 7" W - 800x480		5.7" - 640x480 7" W - 800x480 8.4" - 800x600 10.1" W - 1280x800 10.4" - 800x600 12.1" - 800x600 12.1" - 1024x768 12.1" W - 1280x800 15.0" - 1024x768 15.6" W - 1366x768		7" W - 800x480 10.1" W - 1280x800 12.1" W - 1280x800 15.6" W - 1366x768
TOUCHSCREEN	Resistive 4 wires		Resistive 4 wires for 5.7" and 7" Resistive 5 wires for other sizes		P-CAP Projective Capacitive
FRONT PANEL	Aluminium	True Flat Aluminium	Aluminium	True Flat Aluminium	
PROTECTION GRADE	IP65, Enclosure type 4x - frontal				
PROCESSOR	ARM Cortex A8 processor i.MX535 1 GHz				
SYSTEM MEMORY - RAM	1 GB with DDR3 soldered				
MASS STORAGE	256 MB Read-Only NAND-Flash for operating system and runtime 4 GB eMMC pseudo-SLC, file system organization for projects and applications				
			1 x Slot SD/SDHC v2.0		
LAN	LAN1 Ethernet 100 Mbps (RJ45)		LAN1 Ethernet 100 Mbps (RJ45) LAN2 Ethernet 10/100 Mbps (RJ45)		
USB	1 x USB 2.0 rear (Type-A)		2 x USB 2.0 rear (Type-A)		
SERIAL	1 x RS-232/422/485 (DB15M)				
FIELD BUS					
POWER SUPPLY INPUT			24VDC (18 ÷ 36VDC) Backup for microinterruption, max 500ms, with supercapacitors (optional)		
OPERATING TEMPERATURE	0°C÷50°C				
APPROVALS	CE, cULus LISTED (508)		CE, cULus LISTED (508), ATEX zone 22, cat 3D		CE, cULus LISTED (508), ATEX zone 2/22, cat 3D

RT35 / RT35Q

Panel ARM Cortex A9 multicore based



The ARM based Panel IPC family RT35-RT35Q is based on the ARM Cortex A9 1GHz multicore processor (i.MX6 DualLite). The "all in one" motherboard provides one Gigabit Ethernet port, one USB 2.0 ports and a serial RS232/422/485 interface with rear access, 1 GB DDR3 RAM

and 4 GB Pseudo-SLC eMMC memory. The RT35Q family is available with the new front panels with minimized frame, 16 million colours LED Backlight TFT LCDs from 7" to 12.1", in Wide aspect ratio, with aluminium front panel and a 4 or 5 wires resistive touchscreen, or

aluminium and glass TrueFlat Multitouch front panels, with projected capacitive touchscreen. The RT35 family is available with 16 million colours LED Backlight TFT LCDs from 7" to 12.1", in 4:3 and Wide aspect ratio, with aluminium or aluminium True flat front

panels, 4 or 5 wires resistive touchscreen. All versions with Wide LCDs are also available with aluminium and glass TrueFlat Multitouch front panels, with projected capacitive touchscreen. RT35-RT35Q systems have an isolated 24 VDC power supply input.



+ Highlights

- "All in one" motherboard
- Microsoft Windows Embedded Compact 7 Pro or Linux Yocto operating system
- ARM Cortex A9 (i.MX6 DualLite) processor
- Fanless IPC with 0°C÷50°C operating temperature
- 8.4", 10.4", 12.1" LCDs in 4:3 aspect ratio and 7", 10.1" and 12.1" LCDs in Wide aspect ratio
- Isolated 24 VDC power supply input
- CE, cULus LISTED (61010) certifications
- ATEX area 2/22 certification (only RT35)

Gallery

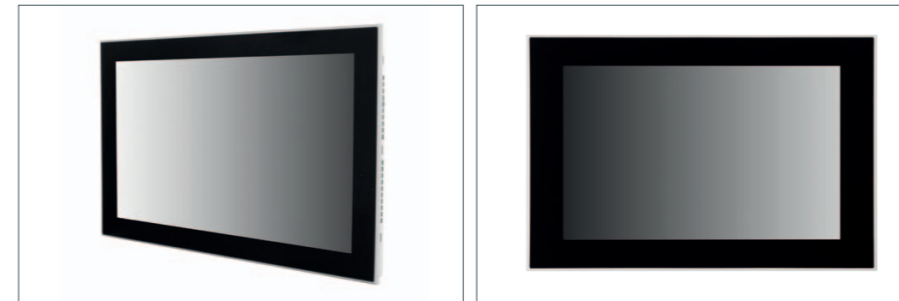

Technical data

	RT35Q	RT35Q-TFM	RT35	RT35-TF	RT35-TFM
O.S. AVAILABLE	Windows Embedded Compact 7 Pro with Datalight Reliance Nitro file system Embedded Linux distribution based on Yocto Project				
PROCESSOR	ARM Cortex A9 1GHz i.MX6 DualLite				
SYSTEM MEMORY - RAM	1 GB DDR3 soldered on board				
MASS STORAGE	4 GB eMMC pseudo-SLC				
LED backlight TFT LCD	7" W - 800x480 10.1" W - 1280x800 12.1" W - 1280x800		7" W - 800x480 8.4" - 800x600 10.1" W - 1280x800 10.4" - 800x600 12.1" - 800x600 12.1" - 1024x768 12.1" W - 1280x800		7" W - 800x480 10.1" W - 1280x800 12.1" W - 1280x800
CUT-OUT	QT		A		
TOUCHSCREEN	Resistive 4 / 5 wires	P-CAP Multitouch	Resistive 4 / 5 wires		P-CAP Multitouch
FRONT PANEL	Aluminium	True Flat Aluminium	Aluminium	True Flat Aluminium	
PROTECTION GRADE	IP65, Enclosure type 4x - front				
INTERFACES	1 x LAN 10/100/1000 Mbps (RJ45) 1 x USB 2.0 rear (Type-A) 1 x RS232/422/485 (DB9M)				
POWER SUPPLY INPUT	24VDC (18÷32VDC) isolated				
OPERATING TEMPERATURE	0°C÷50°C				
APPROVALS	CE, cULus LISTED 61010		CE, cULus LISTED 61010, ATEX zone 22, cat 3D	CE, cULus LISTED 61010, ATEX zone 2/22, cat 3D	

RT40 / RT40Q

Panel ARM Cortex A9 multicore based



The ARM based Panel IPC family RT40-RT40Q is based on the ARM Cortex A9 1GHz multicore processor (i.MX6 DualLite). The "all in one" motherboard provides two Gigabit Ethernet ports, two USB 2.0 ports, a serial RS232/422/485 interface with rear access, 1 GB DDR3 RAM, 8GB Pseudo-SLC eMMC memory and a slot

for a removable MicroSD with rear access. Optionally, an additional RS485 or CAN serial port is available. The RT40Q family is available with the new front panels with minimized frame, 16 million colours LED Backlight TFT LCDs from 7" to 18.5", in Wide aspect ratio, with aluminium front panel and a 4 or 5 wires resistive touchscreen, or

aluminium and glass TrueFlat Multitouch front panels, with projected capacitive touchscreen. The RT40 family is available with 16 million colours LED Backlight TFT LCDs from 7" to 15.6", in 4:3, 5:4 and Wide aspect ratio, with aluminium or aluminium True flat front panels, 4 or 5 wires resistive touchscreen.

All versions with Wide LCDs are also available with aluminium and glass TrueFlat Multitouch front panels, with projected capacitive touchscreen. RT40 systems have an isolated 24 VDC power supply input.



+ Highlights

- "All in one" motherboard
- Microsoft Windows Embedded Compact 7 Pro or Linux Yocto operating system
- ARM Cortex A9 (i.MX6 DualLite) processor
- Fanless IPC with 0°C ÷ 50°C operating temperature
- 8.4", 10.4", 12.1" and 15" LCDs in 4:3 aspect ratio, 17" and 19" LCDs in 5:4 aspect ratio, 7", 10.1", 12.1", 15.6", 18.5", 21.5" and 24" LCDs in Wide aspect ratio
- Isolated 24 VDC power supply input
- CE, cULus LISTED (61010) certifications
- ATEX area 2/22 certification (only RT40)

Gallery

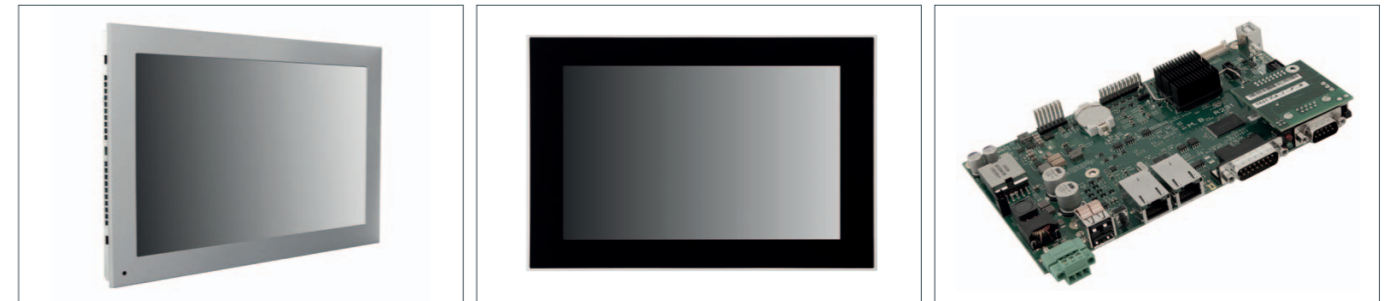

Technical data

	RT40Q	RT40Q-TFM	RT40	RT40-TF	RT40-TFM
O.S. AVAILABLE	Windows Embedded Compact 7 Pro with Datalight Reliance Nitro file system Embedded Linux distribution based on Yocto Project				
PROCESSOR	ARM Cortex A9 1GHz i.MX6 DualLite				
SYSTEM MEMORY - RAM	1 GB DDR3 soldered on board				
MASS STORAGE	8 GB eMMC Pseudo-SLC 1x microSD slot onboard with external access				
LED backlight TFT LCD	7" W - 800x480 10.1" W - 1280x800 12.1" W - 1280x800 15.6" W - 1366x768 18.5" W - 1366x768		7" W - 800x480 8.4" - 800x600 10.1" W - 1280x800 10.4" - 800x600 12.1" - 800x600 12.1" - 1024x768 12.1" W - 1280x800 15.0" - 1024x768 15.6" W - 1366x768		7" W - 800x480 10.1" W - 1280x800 12.1" W - 1280x800 15.6" W - 1366x768
CUT-OUT	QT		A		
TOUCHSCREEN	Resistive 4 / 5 wires	P-CAP Multitouch	Resistive 4 / 5 wires		P-CAP Multitouch
FRONT PANEL	Aluminium	True Flat Aluminium	Aluminium	True Flat Aluminium	
PROTECTION GRADE	IP65, Enclosure type 4x - front				
INTERFACES	2 x LAN 10/100/1000 Mbps (RJ45) 2 x USB 2.0 rear (Type-A) 1 x RS232/422/485 (DB15M)				
ADDITIONAL INTERFACES	1 x RS485 isolated (DB9M) with terminations 1 x CAN isolated channel (DB9M) and terminations 1 x Wireless/Modem adapter				
POWER SUPPLY INPUT	24VDC (18 ÷ 36VDC) isolated				
OPERATING TEMPERATURE	0°C ÷ 50°C				
APPROVALS	CE, cULus LISTED (61010)		CE, cULus LISTED (61010), ATEX zone 22, cat 3D	CE, cULus LISTED (61010), ATEX zone 2/22, cat 3D	

Panel IPCs

ASEM Panel IPCs are low consumption and high computing performance systems, with or without fans, based on Celeron and Core™ i3, i5, i7 dual and quad core processors. Available with TFT LCDs from 6.5" to 24" and aluminium, True Flat aluminium, True Flat stainless steel front panels and resistive touchscreen or True Flat aluminium front panels with glass projected capacitive Multitouch screen.



HT2150 / QT2150

Entry level Intel® Bay Trail™ based fanless panel IPCs



The fanless Panel IPC families HT2150 and QT2150 are entry-level systems, available with small LCD sizes, that offer an excellent performance/price ratio. They are based on the Celeron J1900 2GHz quad core 64 bit processor of the Intel® Bay Trail™ System On Chip (SoC) platform. The "all in one" motherboard provides two Ethernet 10/100/1000Mbps ports, that support "Jumbo Frame" and "Wake on Lan" functionalities,

a USB 3.0 port, a USB 2.0 port and a SATA II CFAST slot with rear external access, an mSATA connector for SATA II SSD, up to 8 GB RAM with one DDR3 SODIMM module and an internal connector for additional interfaces. The QT2150 family is available with the new front panels with minimized frame, 16 million colours LED Backlight TFT LCDs from 7" to 15.6", in 4:3 and Wide aspect ratio, with aluminium front panel and a 5

wires resistive touchscreen, or aluminium and glass TrueFlat Multitouch front panels, with projected capacitive touchscreen. The HT2150 family is available with 16 million colours LED Backlight TFT LCDs from 6.5" to 15.6", in 4:3 and Wide aspect ratio, with aluminium or aluminium True flat front panels, 5 wires resistive touchscreen and an additional USB 2.0 port on front. All versions with Wide LCDs are

also available with aluminium and glass TrueFlat Multitouch front panels, with projected capacitive touchscreen. HT2150/QT2150 systems have an isolated 24 VDC power supply input and optionally an integrated UPS with external battery pack. The systems are available in two versions, the SL with a reduced depth and the S0 with the possibility to install additional interfaces.



+ Highlights

- UBIQUITY remote assistance software providing remote access to the system
- Support to 32 or 64 bit operating systems
- "All in one" motherboard
- High performance Intel® Bay Trail™ SoC platform
- Fanless panel IPC with 0°C÷50°C operating temperature
- 6.5", 8.4", 10.4", 12.1" in 4:3 aspect ratio, 7", 10.1", 12.1" and 15.6" LCDs in Wide aspect ratio
- Isolated 24 VDC power supply input
- Onboard connector for NETcore X fieldbus boards
- Integrated UPS with external battery pack (optional)
- SL version with reduced depth
- CE, cULus LISTED (61010) certifications

Gallery



Add-On boards

Position A

- 1 x RS232/422/485 + 1 x USB 2.0
- 1 x RS232/422/485 isol. + 1 x USB 2.0
- 2 x RS232
- 1/2 x USB 2.0
- 1 x LAN Gigabit + 1 x USB 2.0
- 1 x NETcore X fieldbus board
- Wi-Fi/Bluetooth/Modem

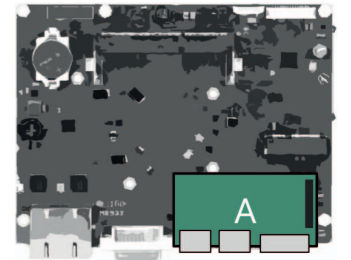

Technical data

	QT2150	QT2150-TFM	HT2150	HT2150-TF	HT2150-TFM
LED backlight TFT LCD	7" W - 800x480 10.1" W - 1280x800 12.1" W - 1280x800 15.6" W - 1366x768		6.5" - 640x480 7" W - 800x480 8.4" - 800x600 10.1" W - 1280x800 10.4" - 800x600 12.1" - 800x600 12.1" - 1024x768 12.1" W - 1280x800 15.0" - 1024x768 15.6" W - 1366x768		7" W - 800x480 10.1" W - 1280x800 12.1" W - 1280x800 15.6" W - 1366x768
CUT-OUT	QT		HT		
FRONT USB	-		1 x USB 2.0, front, protected (Type-A)		-
TOUCHSCREEN	Resistive 5 wires	P-CAP Multitouch	Resistive 5 wires		P-CAP Multitouch
FRONT PANEL	Aluminium	True Flat Aluminium	Aluminium	True Flat Aluminium	
PROTECTION GRADE	IP65 - frontal				
PROCESSOR	Intel® Celeron J1900 2.0Ghz, 4 cores / 4 threads, 2MB L2 cache, soldered				
VIDEO CONTROLLER	Intel® HD Graphics integrated in microprocessor, 688MHz Clock 854MHz Turbo, LVDS 8bit/colour digital interface				
SYSTEM MEMORY - RAM	1GB or 2GB or 4GB or 8GB (1 x SODIMM DDR3 module)				
MASS STORAGE	1 bootable CFAST SATA II slot onboard with external access 1 x onboard connector for direct insertion of mSATA SSD SATA II				
LAN	2 x LAN 10/100/1000Mbps (RJ45 - 2 x Intel® I210)				
USB	1 x USB 3.0 rear (Type-A) 1 x USB 2.0 rear (Type-A)				
ADD-ON INTERFACES (only for S0, max 1)	1 x RS232/422/485 (DB15M)+ 1 x USB 2.0 (Type-A) 1 x RS232/422/485 (DB15M) isolated + 1 x USB 2.0 (Type-A) 2 x RS232 (DB9M) 1 x USB 2.0 (Type-A) 2 x USB 2.0 (Type -A) 1 x LAN 10/100/1000Mbps (RJ45 - Intel® I210) + 1 x USB 2.0 1 x NETcore X fieldbus boards for EtherCAT, EtherNet IP, PROFINET, PROFIBUS, CANopen protocols 1xWi-Fi and Bluetooth/Modem Adapter				
POWER SUPPLY INPUT	24VDC (18÷32VDC) isolated				
POWER SUPPLY OPTIONS	UPS with external battery pack Kit for ATX mode power supply				
O.S. CERTIFIED	Microsoft Windows 7 Pro/Ultimate 32/64 bit, Microsoft Windows Embedded Standard 7E/7P 32/64 bit, Microsoft Windows 8.1 Industry Pro 32/64 bit, Microsoft Windows 10 IoT Enterprise 2016/2019 64 bit				
OPERATING TEMPERATURE	0°C÷50°C				
APPROVALS	CE, cULus LISTED (61010)				

HT2200 / QT2200

Intel® Bay Trail™ based fanless panel IPCs



The fanless Panel IPC families HT2200 and QT2200 are based on the Celeron J1900 2GHz quad core 64 bit processor of the Intel® Bay Trail™ System On Chip (SoC) platform. The "all in one" motherboard provides two Ethernet 10/100/1000Mbps ports, that support "Jumbo Frame" and "Wake on Lan" functionalities, one USB 3.0 port, two USB 2.0 ports, a serial RS232 interface, a DVI-I (DVI-D + VGA) video output and a SATA II CFast slot with rear external access, an

mSATA connector for SATA II SSD, one SATA II connector for the installation of 2.5" HDD/SSD, up to 8 GB RAM with one DDR3 SODIMM module and two internal connectors for additional interfaces. The QT2200 family is available with the new front panels with minimized frame, 16 million colours LED Backlight TFT LCDs from 12.1" to 24", in 4:3 and Wide aspect ratio, with aluminium front panel and a 5 wires resistive touchscreen, or aluminium and glass TrueFlat Multitouch front panels,

with projected capacitive touchscreen. The HT2200 family is available with 16 million colours LED Backlight TFT LCDs from 10.1" to 24", in 4:3, 5:4 and Wide aspect ratio, with aluminium or aluminium True flat front panels, 5 wires resistive touchscreen and an additional USB 2.0 port on front. As an alternative, the systems with 12.1", 15", 17" and 19" LCD can have a Stainless Steel True Flat front panel. All version with Wide LCDs are also available with aluminium

and glass TrueFlat Multitouch front panels, with projected capacitive touchscreen. HT2200/QT2200 systems have an isolated 24 VDC power supply input and optionally an integrated UPS with external battery pack. The systems are available in three versions, the SL with a reduced depth, the S0 with the possibility to install additional interfaces and the S1 with a PCI or PCIe x1 slot.



+ Highlights

- UBIQUITY remote assistance software providing remote access to the system
- Support to 32 or 64 bit operating systems
- "All in one" motherboard
- High performance Intel® Bay Trail™ SoC platform
- Fanless panel IPC with 0°C ÷ 50°C operating temperature
- 10.4", 12.1" LCDs in 4:3 aspect ratio, 17" and 19" LCDs in 5:4 aspect ratio, 10.1", 12.1", 15.6", 18.5", 21.5" and 24" LCDs in Wide aspect ratio
- Isolated 24 VDC power supply input
- Integrated UPS with external battery pack (optional)
- Onboard connector for NETcore X fieldbus boards
- SL version with reduced depth
- S1 version with one PCI or PCIe x1 expansion slot
- CE, cULus LISTED (508) certifications

Gallery

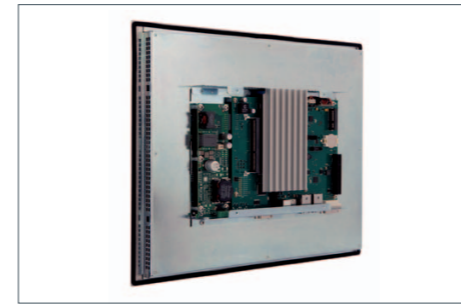

Add-On boards

- Position A**
- 1 x RS232/422/485 + 1 x USB 2.0
 - 1 x RS232/422/485 isol. + 1 x USB 2.0
 - 2 x RS232
 - 2 x USB 2.0
- Position B**
- 1 x LAN Gigabit
 - 1 x NETcore X fieldbus board
 - Wi-Fi/Bluetooth/Modem

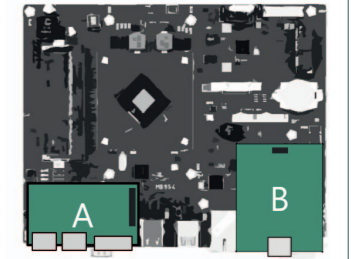

Technical data

	QT2200	QT2200-TFM	HT2200	HT2200-TF	HT2200-TFX	HT2200-TFM
LED backlight TFT LCD	12.1" W - 1280x800 15.6" W - 1366x768 15.6" W - 1920x1080 18.5" W - 1366x768 18.5" W - 1920x1080 21.5" W - 1920x1080 24"W - 1920x1080		10.1" W - 1280x800 (SL) 10.4" - 800x600 12.1" - 800x600 12.1" - 1024x768 12.1" W - 1280x800 15.0" - 1024x768 15.6" W - 1366x768 15.6" W - 1920x1080 17" - 1280x1024 18.5" W - 1366x768 18.5" W - 1920x1080 19" - 1280x1024 21.5" W - 1920x1080 24" W - 1920x1080		12.1" - 800x600 12.1" - 1024x768 15.0" - 1024x768 17" - 1280x1024 19" - 1280x1024	10.1" W - 1280x800 (SL) 12.1" W - 1280x800 15.6" W - 1366x768 15.6" W - 1920x1080 18.5" W - 1366x768 18.5" W - 1920x1080 21.5" W - 1920x1080 24" W - 1920x1080
CUT-OUT	QT		HT			
FRONT USB	-		1 x USB 2.0, front, protected (Type-A)			-
TOUCHSCREEN	Resistive 5 wires	P-CAP Multitouch	Resistive 5 wires			P-CAP Multitouch
FRONT PANEL	Aluminium	True Flat Aluminium	Aluminium	True Flat Aluminium	True Flat Stainless Steel	True Flat Aluminium
PROTECTION GRADE	IP66 - frontal					
PROCESSOR	Intel® Celeron J1900 2.00Ghz (2.42Ghz Burst) a 64 bit, 4 cores / 4 threads, 2MB L2 cache, soldered					
VIDEO CONTROLLER	Intel® HD Graphics integrated in microprocessor, 688MHz Clock 854MHz Turbo, LVDS 8bit/colour digital interface					
SYSTEM MEMORY - RAM	1GB or 2GB or 4GB or 8GB (1 x SODIMM DDR3 module)					
MASS STORAGE	1 x bootable CFast SATA II slot on board with external access 1 x onboard connector for direct insertion of mSATA SSD SATA II					
SL/S0/S1	1 x bootable CFast SATA II slot on board with external access 1 x onboard connector for 2.5" SSD/HDD 24x7 SATA II with internal installation kit					
LAN	2 x LAN 10/100/1000Mbps (RJ45 - 2 x Intel® I210)					
USB	1 x USB 3.0 rear (Type-A) 2 x USB 2.0 rear (Type-A)					
SERIAL	1 x RS232 (DB9M)					
VIDEO OUTPUT	1 x DVI-I (DVI-D + VGA with adapter)					
ADD-ON INTERFACES (only for S0/S1)	1 x RS232/422/485 (DB15M)+ 1 x USB 2.0 (Type-A)					
Position A (max 1)	1 x RS232/422/485 (DB15M) isolated + 1 x USB 2.0 (Type-A)					
	2 x RS232 (DB9M)					
	2 x USB 2.0 (Type-A)					
Position B (max 1)	1 x LAN 10/100/1000Mbps (RJ45 - Intel® I210)					
	1 x NETcore X fieldbus boards for EtherCAT, EtherNet IP, PROFINET, PROFIBUS, CANopen protocols					
	1 x Wi-Fi/Bluetooth/Modem adapter					
EXPANSION SLOTS S1	1 x PCI or 1 x PCIe x1					
POWER SUPPLY INPUT	24VDC (18÷32VDC) isolated					
POWER SUPPLY OPTIONS	UPS with external battery pack Kit for ATX mode power supply					
O.S. CERTIFIED	Microsoft Windows 7 Pro/Ultimate 32/64 bit, Microsoft Windows Embedded Standard 7E/7P 32/64 bit, Microsoft Windows 10 IoT Enterprise 2016/2019 64 bit					
OPERATING TEMPERATURE	0°C ÷ 50°C 0°C ÷ 45°C with 24x7 HDD					
APPROVALS	CE, cULus LISTED (508)					

HT2250 / QT2250 [new]

Entry-level compact panel fanless IPCs based on Intel® Apollo Lake™ platform



The fanless Panel IPC families HT2250 and QT2250 are based on the Intel® Atom™ x5-3930 1.3GHz (1.80GHz Burst) or x7-3950 1.6GHz (2.00GHz Burst) processors of the Intel® Apollo Lake™ System on Chip (SoC) platform. The "all in one" motherboard provides two Gigabit Ethernet ports, that support "Jumbo Frame" and "Wake on Lan" functionalities, three USB 3.0 ports and a SATA III CFast slot

with rear external access, an M.2 connector for a SATA III SSD, up to 8 GB RAM LPDDR4 and one internal connector for additional interfaces. The QT2250 family is available with the new front panels with minimized frame, 16 million colours LED Backlight TFT LCDs from 7" to 24", in Wide aspect ratio, with aluminium front panel and a 5 wires resistive touchscreen, or aluminium and glass TrueFlat

Multitouch front panels, with projected capacitive touchscreen. The HT2250 family is available with 16 million colours LED Backlight TFT LCDs from 7" to 24", in 4:3, 5:4 and Wide aspect ratio, with aluminium or aluminium True flat front panels, 5 wires resistive touchscreen and an additional USB 2.0 port on front. All versions with Wide LCDs are also available with aluminium

and glass TrueFlat Multitouch front panels, with projected capacitive touchscreen. HT2250/QT2250 systems have an isolated 24 VDC power supply input and optionally an integrated UPS with external battery pack. The systems are available in two versions, the SL with a reduced depth and the S0 with the possibility to install additional interfaces.



+ Highlights

- UBIQUITY remote assistance software providing remote access to the system
- Intel Apollo Lake™ SoC platform
- "All in one" motherboard
- Fanless panel IPC with 0°C ÷ 50°C operating temperature
- 8.4", 10.4", 12.1" and 15" LCDs in 4:3 aspect ratio, 17" and 19" LCDs in 5:4 aspect ratio, 7", 10.1", 12.1", 15.6", 17", 18.5", 21.5" and 24" LCDs in Wide aspect ratio
- Isolated 24 VDC power supply input
- Integrated UPS with external battery pack (optional)
- Onboard connector for NETcore X fieldbus boards
- SL version with reduced depth
- CE, cULus LISTED (61010) certifications

Gallery



Add-On boards

Position A

- 1 x RS232/422/485 + 1 x USB 2.0
- 1 x RS232/422/485 isol. + 1 x USB 2.0
- 2 x RS232/422/485
- 2 x RS232/422/485 isol.
- 2 x RS232
- 1 x LAN Gigabit + 1 x USB 2.0
- 2 x USB 2.0
- 1 x NETcore X fieldbus board
- Wireless/Bluetooth/Modem

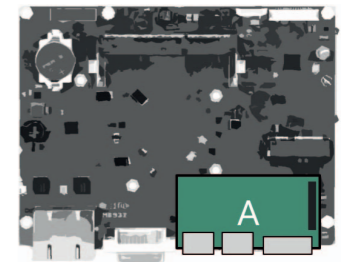

Technical data

	QT2250	QT2250-TFM	HT2250	HT2250-TF	HT2250-TFM	
LED backlight TFT LCD	7" W - 800x480 10.1" W - 1280x800 12.1" W - 1280x800 15.6" W - 1366x768 15.6" W - 1920x1080 18,5" W - 1366x768 18,5" W - 1920x1080 21.5" W - 1920x1080 24" W - 1920x1080		7" W - 800x480 8.4" - 800x600 10.1" W - 1280x800 10.4" - 800x600 12.1" - 800x600 12.1" - 1024x768 12.1" W - 1280x800 17" - 1280x1024	15.0" - 1024x768 15.6" W - 1366x768 15.6" W - 1920x1080 17" - 1280x1024 18,5" W - 1366x768 18,5" W - 1920x1080 21.5" W - 1920x1080 24" W - 1920x1080		7" W - 800x480 10.1" W - 1280x800 12.1" W - 1280x800 15.6" W - 1366x768 15.6" W - 1920x1080 18,5" W - 1366x768 18,5" W - 1920x1080 21.5" W - 1920x1080 24" W - 1920x1080
CUT-OUT	QT		HT			
FRONT USB	-		1 x USB 2.0, front, protected (Type-A)		-	
TOUCHSCREEN	Resistive 5 wires	P-CAP Multitouch	Resistive 5 wires		P-CAP Multitouch	
FRONT PANEL	Aluminium	True Flat Aluminium	Aluminium	True Flat Aluminium		
PROTECTION GRADE	IP65 - frontal					
PROCESSOR	Intel® Atom™ x5-E3930 1.3GHz (1.8GHz Burst), 2 cores / 2 threads, 2MB L2 cache, 14nm Intel® Atom™ x7-E3950 1.6GHz (2.0GHz Burst), 4 cores / 4 threads, 2MB L2 cache, 14nm					
CHIPSET	Intel® Apollo Lake - Included into processor chip (SoC)					
VIDEO CONTROLLER	Intel® HD Graphics 500 integrated in x5-E3930, 400/550MHz Intel® HD Graphics 505 integrated in x7-E3950, 500/650MHz					
SYSTEM MEMORY RAM (soldered)	4GB LP-DDR4 4GB or 8GB LP-DDR4					
MASS STORAGE	"1 x bootable CFast SATA III slot onboard with external access 1 x onboard connector for direct insertion of M.2 SATA III SSD"					
LAN	2 x LAN 10/100/1000Mbps (RJ45 - 2 x Intel® I210)					
USB	3 x USB 3.0 rear (Type-A)					
ADD-ON INTERFACES (only for S0, max 1)	1 x RS232/422/485 (DB15M)+ 1 x USB 2.0 (Type-A) 1 x RS232/422/485 (DB15M) isolated + 1 x USB 2.0 (Type-A) 2 x RS232/422/485 (DB9M) 2 x RS232/422/485 (DB9M) isolated 2 x RS232 (DB9M) 2 x USB 2.0 (Type-A) 1 x LAN 10/100/1000Mbps (RJ45 - Intel® I210) + 1 x USB 2.0 1 x NETcore X fieldbus boards for EtherCAT, EtherNet IP, PROFINET, PROFIBUS, CANopen protocols 1 x Wireless/Bluetooth/Modem adapter					
POWER SUPPLY INPUT	24VDC (18÷32VDC) isolated					
POWER SUPPLY OPTIONS	UPS with external battery pack Kit for ATX mode power supply					
O.S. CERTIFIED	Microsoft Windows 10 IoT Enterprise 2016/2019 64 bit					
OPERATING TEMPERATURE	0°C ÷ 50°C					
APPROVALS	CE, cULus LISTED (61010)					

HT3200 / QT3200

Intel® Broadwell™ U based fanless panel IPCs



The fanless Panel IPC families HT3200 and QT3200 are based on the fifth generation Core i3, i5, i7 and Celeron of the Intel® Broadwell™ U platform. The "all in one" motherboard provides three Ethernet 10/100/1000Mbps ports, that support "Jumbo Frame" and "Wake on Lan" functionalities, two USB 3.0 ports, one USB 2.0 port, a serial RS232 interface, a DVI-I (DVI-D + VGA) video output and a SATA III CFast slot with rear external access, an mSATA connector

for SATA III SSD, one SATA III connector for the installation of 2.5" HDD/ SSD, up to 16 GB RAM with one DDR3 SODIMM module and two internal connectors for additional interfaces. The QT3200 family is available with the new front panels with minimized frame, 16 million colours LED Backlight TFT LCDs from 12.1" to 24", in 4:3 and Wide aspect ratio, with aluminium or aluminium and glass TrueFlat Multitouch front panels,

with projected capacitive touchscreen. The HT3200 family is available with 16 million colours LED Backlight TFT LCDs from 12.1" to 24", in 4:3, 5:4 and Wide aspect ratio, with aluminium or aluminium True flat front panels, 5 wires resistive touchscreen and an additional USB 2.0 port on front. As an alternative, the systems with 12.1", 15", 17" and 19" LCD can have a Stainless Steel True Flat front panel. All version with Wide LCDs are also available with aluminium

and glass TrueFlat Multitouch front panels, with projected capacitive touchscreen. HT3200/QT3200 systems have an isolated 24 VDC power supply input and optionally an integrated UPS with external battery pack. The systems are available in three versions, the SL with a reduced depth, the S0 with the possibility to install additional interfaces and the S1 with a PCI or PCIe x4 slot.



+ Highlights

- UBIQUITY remote assistance software providing remote access to the system
- "All in one" motherboard
- 15W processors - Intel® Broadwell™ U platform
- Fanless panel IPC with 0°C ÷ 50°C operating temperature
- 12.1" in 4:3 aspect ratio, 17" and 19" LCDs in 5:4 aspect ratio, 12.1", 15.6", 18.5", 21.5" and 24" LCDs in Wide aspect ratio
- Isolated 24 VDC power supply input
- Integrated UPS with external battery pack (optional)
- Onboard connector for NETcore X fieldbus boards
- SL version with reduced depth
- S1 version with one PCI or PCIe x4 expansion slot
- CE, cULus LISTED (61010) certifications

Gallery



Add-On boards

Position A

- 1 x RS232/422/485 + 1 x USB 2.0
- 1 x RS232/422/485 isol. + 1 x USB 2.0
- 2 x RS232
- 2 x USB 2.0

Position B

- 1 x LAN Gigabit
- 1 x NETcore X fieldbus board
- Wi-Fi/Bluetooth/Modem

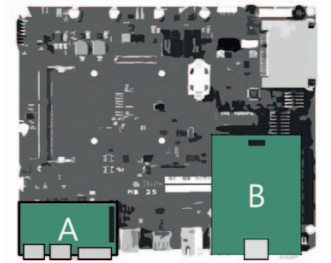

Technical data

	QT3200	QT3200-TFM	HT3200	HT3200-TF	HT3200-TFX	HT3200-TFM
LED backlight TFT LCD	15.6" W - 1366x768 15.6" W - 1920x1080 18.5" W - 1366x768 18.5" W - 1920x1080 21.5" W - 1920x1080 24" W - 1920x1080		12.1" - 800x600 12.1" - 1024x768 12.1" W - 1280x800 15.0" - 1024x768 15.6" W - 1366x768 15.6" W - 1920x1080	17" - 1280x1024 18.5" W - 1366x768 18.5" W - 1920x1080 19" - 1280x1024 21.5" W - 1920x1080 24" W - 1920x1080		12.1" - 800x600 12.1" - 1024x768 15.0" - 1024x768 17" - 1280x1024 19" - 1280x1024
CUT-OUT	QT		HT			
FRONT USB			1 x USB 2.0, front, protected (Type-A)			
TOUCHSCREEN	Resistive 5 wires	P-CAP Multitouch	Resistive 5 wires			P-CAP Multitouch
FRONT PANEL	Aluminium	True Flat Aluminium	Aluminium	True Flat Aluminium	Stainless Steel True Flat	True Flat Aluminium
PROTECTION GRADE	IP65 - frontal					
PROCESSOR (soldered)	Intel® Celeron 3765U 1,9Ghz, 2 cores - 2 threads - 2MB smart cache - 15W Intel® Core™ i3-5010U 2,1Ghz, 2 cores - 4 threads - 3MB smart cache - 15W Intel® Core™ i5-5350U 1,8Ghz (2,9Ghz Turbo), 2 cores - 4 threads - 3MB smart cache - 15W Intel® Core™ i7-5650U 2,2Ghz (3,1Ghz Turbo), 2 cores - 4 threads - 4MB smart cache - 15W					
CHIPSET	Intel® Broadwell PCH-LP (Platform Controller Hub - Low Power) • Included into processor chip					
VIDEO CONTROLLER	Intel® HD Graphics integrated in microprocessor Celeron 3765U, 850MHz Clock Intel® HD Graphics 5500 integrated in microprocessor i3, 900MHz Clock Intel® HD Graphics 6000 integrated in microprocessor i5, i7, 1GHz Clock with LVDS 8bit/color digital interface					
SYSTEM MEMORY - RAM	2GB or 4GB or 8GB or 16GB (1 x SODIMM DDR3 module)					
MASS STORAGE	1 x bootable CFast SATA III slot onboard with external access 1 x onboard connector for direct insertion of mSATA SSD SATA III					
	SL					
	S0/S1	1 x bootable CFast SATA III slot onboard with external access 1 x onboard connector for direct insertion of mSATA SSD SATA III 1 x onboard connector for 2.5" SSD/HDD SATA III with internal installation kit				
LAN	3 x LAN 10/100/1000 Mbps (RJ45 - 2 x Intel® I210-AT, 1 x Intel® I218-LM)					
USB	2 x USB 3.0 rear (Type-A) 1 x USB 2.0 rear (Type-A)					
SERIAL	1 x RS232 (DB9M)					
VIDEO OUTPUT	1 x DVI-D					
ADD-ON INTERFACES (only S0/S1)	1 x RS232/422/485 (DB15M)+ 1 x USB 2.0 (Type-A)					
	Position A (max 1)	1 x RS232/422/485 (DB15M) isolated + 1 x USB 2.0 (Type-A) 2 x RS232 (DB9M) 2 x USB 2.0 (Type-A)				
	Position B (max 1)	1 x LAN 10/100/1000Mbps (RJ45 - Intel® I210) 1 x NETcore X fieldbus boards for EtherCAT, EtherNet IP, PROFINET, PROFIBUS, CANopen protocols 1 x Wi-Fi/Bluetooth/Modem adapter				
EXPANSION SLOTS	S1	1 x PCI or 1 x PCIe x4 (5 Gb/s)				
POWER SUPPLY INPUT	24VDC (18÷32VDC) isolated					
POWER SUPPLY OPTIONS	UPS with external battery pack Kit for ATX mode power supply					
O.S. CERTIFIED	Microsoft Windows 7 Pro/Ultimate 32/64bit, Microsoft Windows Embedded Standard 7E/7P 32/64 bit (7E not on TFM), Microsoft Windows 10 IoT Enterprise 2016/2019 64bit					
OPERATING TEMPERATURE	0°C÷50°C					
	0°C÷45°C with 24x7 HDD					
APPROVALS	CE, cULus LISTED (61010)					

HT3500 / QT3500 [new]

Panel IPC fanless based on Intel® Kaby Lake™ U platform



The fanless Panel IPC families HT3500 and QT3500 are based on the seventh generation Core i3, i5, i7 and Celeron of the Intel® Kaby Lake™ U platform. The "all in one" motherboard provides three Gigabit Ethernet ports, that support "Jumbo Frame" and "Wake on Lan" functionalities, four USB 3.0 ports, a serial RS232 interface, a Display Port dual mode video output and a SATA III CFast slot with rear external access, an M.2 connector for an NVMe/SATA III SSD, one SATA III connector for the installation of

a 2.5" HDD/ SSD, up to 16 GB RAM with one DDR4 SODIMM module and two internal connectors for additional interfaces, including RVL for the remotation of the video and USB signals up to 100m (Remote Video Link). The QT3500 family is available with the new front panels with minimized frame, 16 million colours LED Backlight TFT LCDs from 15.6" to 24", in 4:3 and Wide aspect ratio, with aluminium front panel and a 5 wires resistive touchscreen, or aluminium and glass TrueFlat

Multitouch front panels, with projected capacitive touchscreen. The HT3500 family is available with 16 million colours LED Backlight TFT LCDs from 12.1" to 24", in 4:3, 5:4 and Wide aspect ratio, with aluminium or aluminium True flat front panels, 5 wires resistive touchscreen and an additional USB 2.0 port on front. As an alternative, the systems with 12.1", 15", 17" and 19" LCD can have a Stainless Steel True Flat front panel. All versions with Wide LCDs are also

available with aluminium and glass TrueFlat Multitouch front panels, with projected capacitive touchscreen. HT3500/QT3500 systems have an isolated 24 VDC power supply input and optionally an integrated UPS with external battery pack. The systems are available in three versions, the SL with a reduced depth, the S0 with the possibility to install additional interfaces and the S1 with a PCI or PCIe x4 slot.



+ Highlights

- UBIQUITY remote assistance software providing remote access to the system
- Seventh generation Core i3, i5, i7 and Celeron of the Intel® Kaby Lake™ U 15W platform.
- "All in one" motherboard
- Fanless panel IPC with 0°C ÷ 50°C operating temperature
- 12.1" and 15" LCDs in 4:3 aspect ratio, 17" and 19" LCDs in 5:4 aspect ratio, 12.1", 15.6", 18.5", 21.5" and 24" LCDs in Wide aspect ratio
- Isolated 24 VDC power supply input
- Integrated UPS with external battery pack (optional)
- Onboard connector for NETcore X fieldbus boards
- SL version with reduced depth
- S1 version with one PCI or PCIe x4 expansion slot
- CE, cULus LISTED (61010) certifications

Gallery



Add-On boards

Position A

- 1 x RS232/422/485 + 1 x USB 2.0
- 1 x RS232/422/485 isol. + 1 x USB 2.0
- 1 x RS232 + 1 x USB 2.0
- 2 x RS232
- 2 x USB 2.0

Position B

- 1 x LAN Gigabit
- 1 x DVI-D
- 1 x RJ45 Remote Video Link (RVL OUT)
- 1 x NETcore X fieldbus board
- Wi-Fi/Bluetooth/Modem

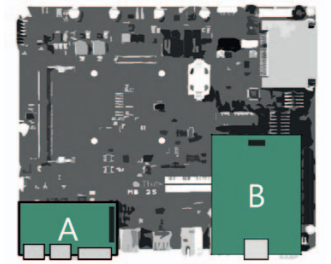

Technical data

	QT3500	QT3500-TFM	HT3500	HT3500-TF	HT3500-TFX	HT3500-TFM
LED backlight TFT LCD	15.6" W - 1366x768 15.6" W - 1920x1080 18.5" W - 1366x768 18.5" W - 1920x1080 21.5" W - 1920x1080 24" W - 1920x1080		12.1" - 800x600 12.1" - 1024x768 12.1" W - 1280x800 15.0" - 1024x768 15.6" W - 1366x768 15.6" W - 1920x1080	17" - 1280x1024 18.5" W - 1366x768 18.5" W - 1920x1080 19" - 1280x1024 21.5" W - 1920x1080 24" W - 1920x1080		12.1" - 800x600 12.1" - 1024x768 15.0" - 1024x768 17" - 1280x1024 19" - 1280x1024
CUT-OUT	QT		HT			
FRONT USB	-		1 x USB 2.0, front, protected (Type-A)			-
TOUCHSCREEN	Resistive 5 wires	P-CAP Multitouch	Resistive 5 wires			P-CAP Multitouch
FRONT PANEL	Aluminium	True Flat Aluminium	Aluminium	True Flat Aluminium	Stainless Steel True Flat	True Flat Aluminium
PROTECTION GRADE	IP65 - frontal					
PROCESSOR (soldered)	Intel® Celeron 3965U 2.20GHz 64bit, 2 cores / 2 threads, 2MB Smart cache Intel® Core i3-7100U 2.40GHz 64bit, 2 cores / 4 threads, 3MB Smart cache Intel® Core i5-7300U 2.60GHz (3.50GHz Turbo) 64bit, 2 cores / 4 threads, 3MB Smart cache Intel® Core i7-7600U 2.80GHz (3.90GHz Turbo) 64bit, 2 cores / 4 threads, 4MB Smart cache					
CHIPSET	Intel® Broadwell PCH-LP (Platform Controller Hub - Low Power) • Included into processor chip					
VIDEO CONTROLLER	Intel® HD Graphics 610 integrated in microprocessor Celeron 3965U • 300MHz/900MHz Intel® HD Graphics 620 integrated in Core i3 processors • 300MHz/1.00GHz Intel® HD Graphics 620 integrated in Core i5 processors • 300MHz/1.10GHz Intel® HD Graphics 620 integrated in Core i7 processor • 300MHz/1.15GHz DirectX 12 and OpenGL 4.5 support					
SYSTEM MEMORY - RAM	4GB or 8GB or 16GB (1 x SODIMM DDR4 module)					
MASS STORAGE	1 x bootable CFast SATA III slot onboard with external access 1 x onboard connector for direct insertion of M.2 2280 NVMe/SATA III SSD					
	SL	1 x bootable CFast SATA III slot onboard with external access 1 x onboard connector for direct insertion of M.2 2280 NVMe/SATA III SSD				
	S0/S1	1 x bootable CFast SATA III slot onboard with external access 1 x onboard connector for direct insertion of M.2 2280 NVMe/SATA III SSD 1 x onboard connector for 2.5" SSD/HDD SATA III with internal installation kit				
LAN	3 x LAN 10/100/1000 Mbps (RJ45 - 2 x Intel® I210-AT, 1 x Intel® I219-LM)					
USB	4 x USB 3.0 rear (Type-A)					
SERIAL	1 x RS232 (DB9M)					
VIDEO OUTPUT	1 x DP++					
ADD-ON INTERFACES (only S0/S1)	1 x RS232/422/485 (DB15M) + 1 x USB 2.0 (Type-A)					
	1 x RS232/422/485 (DB15M) isolated + 1 x USB 2.0 (Type-A)					
	1 x RS232 (DB9M) + 1 x USB 2.0 (Type-A)					
	2 x RS232 (DB9M)					
	2 x USB 2.0 (Type-A)					
	1 x LAN 10/100/1000Mbps (RJ45 - Intel® I210)					
	1 x DVI-D					
	1 x RJ45 connector Remote Video Link (RVL OUT)					
	1 x NETcore X fieldbus boards for EtherCAT, EtherNet IP, PROFINET, PROFIBUS, CANopen protocols					
	1 x Wi-Fi/Bluetooth/Modem adapter					
EXPANSION SLOTS	S1 1 x PCI or 1 x PCIe x4 (5 Gb/s)					
POWER SUPPLY INPUT	24VDC (18÷32VDC) isolated					
POWER SUPPLY OPTIONS	UPS with external battery pack Kit for ATX mode power supply					
O.S. CERTIFIED	Microsoft Windows 10 IoT Enterprise 2016/2019 64bit					
OPERATING TEMPERATURE	0° ÷ 50°C					
	0° - 45°C with 24x7 HDD					
APPROVALS	CE, cULus LISTED (61010)					

HT3400/QT3400 / HT3600/QT3600

Intel® Skylake™ H and Kaby Lake™ H based fanless panel IPCs



The fanless Panel IPC families HT3400 and QT3400 are based on the 6th generation Core i3, i5, i7 and Celeron processors of the Intel® Skylake™ H and the HT3600 and QT3600 families are based on the 7th generation Core i3, i5, i7 processors of the Intel® Kaby Lake™ H platform. The "all in one" motherboard provides four Ethernet 10/100/1000Mbps ports, that support "Jumbo Frame" and "Wake on Lan" functionalities, three USB 3.0 ports, two USB 2.0 port, a serial RS232 interface, a DVI-D video output

and a SATA III CFAST slot with rear external access, an mSATA connector for a SATA III SSD, one SATA III connector for 2.5" SSD/HDD, up to 32 GB RAM with two DDR4 SODIMM modules and two internal connectors for additional interfaces, including RVL for the remotation of the video and USB signals up to 100m (Remote Video Link). The QT3400 / QT3600 families are available with the new front panels with minimized frame, 16 million colours LED Backlight TFT LCDs from 15.6" to 24", in 4:3 and Wide aspect

ratio, with aluminium front panel and a 5 wires resistive touchscreen, or aluminium and glass TrueFlat Multitouch front panels, with projected capacitive touchscreen. The HT3400 / HT3600 families are available with 16 million colours LED Backlight TFT LCDs from 12.1" to 24", in 4:3, 5:4 and Wide aspect ratio, with aluminium or aluminium True flat front panels, 5 wires resistive touchscreen and an additional USB 2.0 port on front. As an alternative, the systems with 12.1", 15", 17" and 19" LCD can have a

Stainless Steel True Flat front panel. All versions with Wide LCDs are also available with aluminium and glass TrueFlat Multitouch front panels, with projected capacitive touchscreen. The systems have an isolated 24 VDC power supply input and optionally an integrated UPS with external battery pack. The systems are available in three versions, the S0 with the possibility to install additional interfaces, the S1 with a PCI or PCIe x4 slot and the D2 with two extractable 2.5" SSDs/ HDDs.



Highlights

- UBIQUITY remote assistance software providing remote access to the system
- High performance Intel® Skylake™ H (HT/QT3400) and Kaby Lake™ H (HT/QT3600) platforms
- "All in one" motherboard
- Fanless panel IPC with 0°C ÷ 50°C operating temperature
- 12.1" LCDs in 4:3 aspect ratio, 17" and 19" LCDs in 5:4 aspect ratio, 15.6", 18.5", 21.5" and 24" LCDs in Wide aspect ratio
- Isolated 24 VDC power supply input
- Integrated UPS with external battery pack (optional)
- Onboard connectors for NETcore X fieldbus boards
- S1 version with one PCI or PCIe x4 expansion slot
- CE, cULus LISTED (61010) certifications

Gallery



Add-On boards

Position A

- 1 x RS232/422/485 + 1 x USB 2.0
- 1 x RS232/422/485 isol. + 1 x USB 2.0
- 2 x RS232
- 2 x USB 2.0
- 1 x NETcore X fieldbus board

Position B

- 1 x LAN Gigabit
- 1/2 x RJ45 Remote Video Link (RVL OUT)
- 2 x Display Port dual mode
- 1 x NETcore X fieldbus board
- Wi-Fi/Bluetooth/Modem

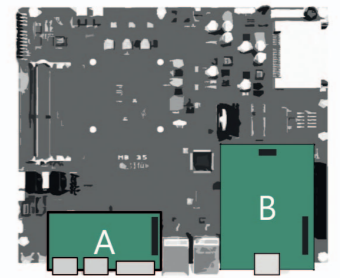

Technical data

	QT3400/3600	QT3400/3600-TFM	HT3400/3600	HT3400/3600-TF	HT3400/3600-TFX	HT3400/3600-TFM
LED backlight TFT LCD	15.6" W - 1366x768 15.6" W - 1920x1080 18.5" W - 1366x768 18.5" W - 1920x1080 21.5" W - 1920x1080 24" W - 1920x1080		12.1" - 800x600 12.1" - 1024x768 12.1" W - 1280x800 15.0" - 1024x768 15.6" W - 1366x768 15.6" W - 1920x1080	17" - 1280x1024 18.5" W - 1366x768 18.5" W - 1920x1080 19" - 1280x1024 21.5" W - 1920x1080 24" W - 1920x1080	12.1" - 800x600 12.1" - 1024x768 15.0" - 1024x768 17" - 1280x1024 19" - 1280x1024	12.1" W - 1280x800 15.6" W - 1366x768 15.6" W - 1920x1080 18.5" W - 1366x768 18.5" W - 1920x1080 21.5" W - 1920x1080 24" W - 1920x1080
CUT-OUT	QT		HT			
FRONT USB	-		1 x USB 2.0, front, protected (Type-A)			
TOUCHSCREEN	Resistive 5 wires	P-CAP Multitouch	Resistive 5 wires			P-CAP Multitouch
FRONT PANEL	Aluminium	True Flat Aluminium	Aluminium	True Flat Aluminium	True Flat Stainless Steel	True Flat Aluminium
PROTECTION GRADE	IP65 - frontal					
PROCESSOR (soldered)	Intel® Celeron G3900E 2.40GHz 64bit, 2 cores / 2 threads, 2MB Smart cache Intel® Core i3-6100E 2.70GHz 64bit, 2 cores / 4 threads, 3MB Smart cache Intel® Core i5-6440EQ 2.70GHz (3.40GHz Turbo) 64bit, 4 cores / 4 threads, 6MB Smart cache Intel® Core i7-6820EQ 2.80GHz (3.50GHz Turbo) 64bit, 4 cores / 8 threads, 8MB Smart cache Intel® Core i3-7100E 2.90GHz 64bit, 2 cores / 4 threads, 3MB Smart cache Intel® Core i5-7440EQ 2.90GHz (3.60GHz Turbo) 64bit, 4 cores / 4 threads, 6MB Smart cache Intel® Core i7-7820EQ 3.00GHz (3.70GHz Turbo) 64bit, 4 cores / 8 threads, 8MB Smart cache					
CHIPSET	xx3400 Intel® HM170 PCH (Platform Controller Hub) xx3600 Intel® HM175 PCH (Platform Controller Hub)					
VIDEO CONTROLLER	Intel® HD Graphics 510 integrated in Celeron processor • 350MHz/950MHz • DirectX 12 and OpenGL 4.4 support Intel® HD Graphics 530 integrated in Core i3 processor • 350MHz/950MHz • DirectX 12 and OpenGL 4.4 support Intel® HD Graphics 530 integrated in Core i5, Core i7processors • 350MHz/1,00GHz • DirectX 12 and OpenGL 4.4 support Intel® HD Graphics 630 integrated in Core i3 processor • 350MHz/950MHz • DirectX 12 and OpenGL 4.5 support Intel® HD Graphics 630 integrated in Core i5, Core i7processors • 350MHz/1,00GHz • DirectX 12 and OpenGL 4.5 support					
SYSTEM MEMORY - RAM	4GB (1 x SODIMM DDR4 module) or 8GB or 16GB or 32GB (2 x SODIMM DDR4 modules)					
TPM	TPM module (optional)					
MASS STORAGE	1 bootable CFAST SATA III slot onboard with external access - 1 x onboard connector for direct insertion of mSATA SSD SATA III 1 x onboard connector for 2.5" SSDs/HDDs SATA III with internal installation kit					
OPTIONS D2	Up to 2 extractable 2.5" SSD/HDD SATA III devices					
USB	3 x USB 3.0, rear (Type-A) - 2 x USB 2.0, rear (Type-A)					
SERIAL	1 x RS232 (DB9M)					
VIDEO OUTPUT	1 x DVI-D					
ADD-ON INTERFACES	1 x RS232/422/485 (DB15M) + 1 x USB 2.0 (Type-A)					
Position A (max 1)	1 x RS232/422/485 (DB15M) isolated + 1 x USB 2.0 (Type-A)					
	2 x RS232 (DB9M)					
	2 x USB 2.0 (Type-A)					
Position B (max 1)	1 x NETcore X fieldbus boards for EtherCAT, EtherNet IP, PROFINET, PROFIBUS, CANopen protocols					
	1 x RJ45 connector Remote Video Link (RVL OUT)					
	2 x RJ45 connectors Remote Video Link (RVL OUT)					
EXPANSION SLOTS S1	2 x DP++ Video output					
	1 x LAN 10/100/1000Mbps (RJ45 - Intel® I210)					
	1 x NETcore X fieldbus boards for EtherCAT, EtherNet IP, PROFINET, PROFIBUS, CANopen protocols					
POWER SUPPLY INPUT	1 x Wi-Fi/Bluetooth/Modem adapter					
POWER SUPPLY OPTIONS	1 x PCI or 1 x PCIe x4 (5 Gb/s)					
O.S. CERTIFIED	24VDC (18÷32VDC) isolated					
xx3400	UPS with external battery pack					
	Kit for ATX mode power supply (optional)					
xx3600	Microsoft Windows 7 Pro/Ultimate 32/64bit					
	Microsoft Windows Embedded Standard 7E/7P 32/64 bit (7E not on TFM)					
OPERATING TEMPERATURE	Microsoft Windows 10 IoT Enterprise 2016/2019 64bit					
	Microsoft Windows 10 IoT Enterprise 2016/2019 64bit					
APPROVALS	0°C ÷ 50°C					
	0°C ÷ 45°C with 24x7 HDD or Core i7 processors					
	CE, cULus LISTED (61010)					

HT5400/5600 / QT5400/5600 [new]

Intel® Skylake™ S and Kaby Lake™ S based highly expandable panel IPCs



The panel IPC families HT5400 and QT5400 are based on the 6th generation Core i3, i5, i7 and Celeron processors of the Intel® Skylake™ S and the HT5600 and QT5600 families are based on the 7th generation Core i3, i5, i7 and Celeron processors of the Intel® Kaby Lake™ S platform. The "all in one" motherboard provides four Ethernet 10/100/1000Mbps ports, that support "Jumbo Frame" and "Wake on Lan" functionalities, four USB 3.0 ports, a serial RS232 interface, a DVI-D video output, a SATA III CFast slot with rear external access, an

M.2 2242/2280 SSD key M connector for a PCIe x4 SSD, two SATA III connectors for 2.5" SSDs/HDDs (optionally on extractable drawers), the possibility to set the mass storage drives in RAID 0, 1 configuration, up to 32 GB RAM with two DDR4 SODIMM modules and two internal connectors for additional interfaces, including RVL for the remotation of the video and USB signals up to 100m (Remote Video Link). The QT5400 / QT5600 families are available with the new front panels with minimized frame, 16 million colours LED

Backlight TFT LCDs from 15.6" to 24", in Wide aspect ratio, with aluminium front panel and a 5 wires resistive touchscreen, or aluminium and glass TrueFlat Multitouch front panels, with projected capacitive touchscreen. The HT5400 / HT5600 families are available with 16 million colours LED Backlight TFT LCDs from 15" to 24", in 4:3, 5:4 and Wide aspect ratio, with aluminium or aluminium True flat front panels, 5 wires resistive touchscreen and an additional USB 2.0 port on front. As an alternative, the systems with 15", 17" and

19" LCD can have a Stainless Steel True Flat front panel. All versions with Wide LCDs are also available with aluminium and glass TrueFlat Multitouch front panels, with projected capacitive touchscreen. The systems have an isolated 24 VDC power supply input or, as an alternative, a 115/230 VAC power supply. The systems are available in three versions, the S0 with the possibility to install additional interfaces, the S1 with a x16 PCIe slot and the S3 with two x8 and a x4 PCIe slots or a x16, a x4 and a x1 PCIe slots.



+ Highlights

- UBIQUITY remote assistance software providing remote access to the system
- High performance Intel® Skylake™ S (HT/QT5400) and Kaby Lake™ S (HT/QT5600) platforms
- RAID 0,1 (optional)
- "All in one" motherboard
- Panel IPC with 0°C÷50°C operating temperature
- 15" LCD in 4:3 aspect ratio, 17" and 19" LCDs in 5:4 aspect ratio, 15.6", 18.5", 21.5" and 24" LCDs in Wide aspect ratio
- 115/230 VAC or Isolated 24 VDC power supply input
- S1 version with one PCIe x16 expansion slot
- S3 version with one x16, one x4 and one x1 PCIe expansion slots or two x8 and one x4 PCIe expansion slots
- CE, cULus LISTED (61010) certifications

Gallery



Add-On boards

Position A

- 1 x RS232/422/485 + 1 x USB 2.0
- 1 x RS232/422/485 isol. + 1 x USB 2.0
- 2 x RS232
- 2 x USB 2.0
- 1 x NETCore X fieldbus board

Position B

- 1 x LAN Gigabit
- 1/2 x RJ45 Remote Video Link (RVL OUT)
- 2 x Display Port dual mode
- 1 x NETCore X fieldbus board
- Wi-Fi/Bluetooth/Modem

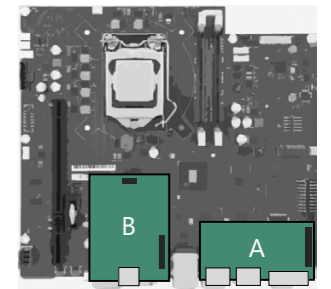

Technical data

	QT5400/5600	QT5400/5600-TFM	HT5400/5600	HT5400/5600-TF	HT5400/5600-TFX	HT5400/5600-TFM
LED backlight TFT LCD	15.6" W - 1366x768 15.6" W - 1920x1080 18.5" W - 1366x768 18.5" W - 1920x1080 21.5" W - 1920x1080 24" W - 1920x1080	15.6" W - 1366x768 15.6" W - 1920x1080 18.5" W - 1366x768 18.5" W - 1920x1080 21.5" W - 1920x1080 24" W - 1920x1080	15.0" - 1024x768 15.6" W - 1366x768 15.6" W - 1920x1080 17" - 1280x1024 18.5" W - 1366x768 18.5" W - 1920x1080	19" - 1280x1024 21.5" W - 1920x1080 24" W - 1920x1080	15.0" - 1024x768 17" - 1280x1024 19" - 1280x1024	15.6" W - 1366x768 15.6" W - 1920x1080 18.5" W - 1366x768 18.5" W - 1920x1080 21.5" W - 1920x1080 24" W - 1920x1080
CUT-OUT	QT		HT			
FRONT USB	-		1 x USB 2.0, front, protected (Type-A)		-	
TOUCHSCREEN	Resistive 5 wires	P-CAP Multitouch	Resistive 5 wires			P-CAP Multitouch
FRONT PANEL	Aluminium	True Flat Aluminium	Aluminium	True Flat Aluminium	Stainless Steel True Flat	True Flat Aluminium
PROTECTION GRADE	IP65 - frontal					
PROCESSOR (soldered)	Intel® Celeron G3900 2.8GHz, 2 cores, 2 Cores - 2 threads - 2MB smart cache Intel® Core™ i3-6100 3.7GHz, 2 Cores - 4 threads - 3MB smart cache Intel® Core™ i5-6500 3.2GHz (3.6GHz Turbo), 4 Cores - 4 threads - 6MB smart cache Intel® Core™ i7-6700 3.4GHz (4.0GHz Turbo), 4 Cores - 8 threads - 8MB smart cache Intel® Celeron G3930TE 2.7GHz, 2 cores - 2 threads - 2MB smart cache Intel® Core™ i3-7101E 3.9GHz, 2 Cores - 4 threads - 3MB smart cache Intel® Core™ i5-7500 3.4GHz (3.8GHz Turbo), 4 Cores - 4 threads - 6MB smart cache Intel® Core™ i7-7700 3.6GHz (4.2GHz Turbo), 4 Cores - 8 threads - 8MB smart cache					
CHIPSET	Intel® C236 PCH (Platform Controller Hub)					
VIDEO CONTROLLER	Intel® HD Graphics 510 integrated in Celeron G3900, 350/950MHz Clock Intel® HD Graphics 530 integrated in i3-6100 / i5-6500, 350/1.05GHz Clock Intel® HD Graphics 530 integrated in i7-6700, 350MHz/1.15GHz Clock Intel® HD Graphics 610 integrated in Celeron G3930TE, 350/950MHz Clock Intel® HD Graphics 630 integrated in i3-7101E / i5-7500, 350/1.10GHz Clock Intel® HD Graphics 630 integrated in i7-7700 350/1.15GHz Clock					
SYSTEM MEMORY - RAM	4GB (1 x SODIMM DDR4 module) / 8GB/16GB/32GB (2 x SODIMM DDR4 modules)					
TPM	TPM module (optional)					
MASS STORAGE	1 x bootable CFast SATA III slot on board with external rear access 1 x onboard connector for direct insertion of M.2 2242/2280 SSD key M PCIe4 2 x onboard connector for 2.5" SSDs/HDDs SATA III					
OPTIONS	S0	1 x extractable drawer for 2.5" units				
	S1/S3	2 x extractable drawers for 2.5" units				
RAID CONTROLLER	Integrated into chipset Intel® C236					
LAN	4 x LAN 10/100/1000Mbps (RJ45 - 3 x Intel® I210 + 1 x Intel® I219LM)					
USB	3 x USB 3.0, rear (Type-A) - 2 x USB 2.0, rear (Type-A)					
SERIAL	1 x RS232 (DB9M)					
VIDEO OUTPUT	1 x DVI-D					
ADD-ON INTERFACES (max 1)	1 x RS232/422/485 (DB15M) + 1 x USB 2.0 (Type-A) 1 x RS232/422/485 (DB15M) isolated + 1 x USB 2.0 (Type-A) 2 x RS232 (DB9M) 2 x USB 2.0 (Type-A) 1 x LAN 10/100/1000Mbps (RJ45 - Intel® I210) + 1 x USB 2.0 (Type-A) 1 x LAN 10/100/1000Mbps (RJ45 - Intel® I210) 1 x RJ45 connector Remote Video Link (RVL OUT) 2 x RJ45 connectors Remote Video Link (RVL OUT) 2 x DP++ Video output (no audio) 1 x NETCore X fieldbus boards for EtherCAT, EtherNet IP, PROFINET, PROFIBUS, CANopen protocols 1 x Wi-Fi/Bluetooth/Modem adapter					
EXPANSION SLOTS	S1	1 x PCIe x16				
	S3	1x PCIe x16 + 1x PCIe x4 + 1x PCIe x1 - 2 x PCIe x8 + 1 x PCIe x4				
POWER SUPPLY INPUT	24VDC (18÷32VDC) isolated - 115/230VAC					
POWER SUPPLY OPTIONS	Kit for ATX mode power supply (optional)					
O.S. CERTIFIED	xx5400	Microsoft Windows 10 IoT Enterprise 2019 64bit • Microsoft Windows 10 IoT Enterprise 2016 64bit • Windows 7 Pro/Ultimate 64bit • Windows Embedded Standard 7E/7P 64 bit • Microsoft Windows Server 2016/2019 Standard				
	xx5600	Microsoft Windows 10 IoT Enterprise 2019 64bit • Microsoft Windows 10 IoT Enterprise 2016 64bit • Microsoft Windows Server 2016/2019 Standard				
OPERATING TEMPERATURE	0°C÷50°C					
APPROVALS	0°C÷45°C with 24x7 HDD CE, cULus LISTED (61010)					

Book Mounting IPCs



ASEM recently completed its Box IPCs portfolio with a complete range of book mounting systems, combining performances, design, ergonomics and configurability. Based on ARM Cortex A9 or Intel® Apollo Lake™, Bay Trail™, Skylake™ and Kaby Lake™ platforms, they are supplied with a sturdy aluminium or plastic chassis, highly refined in every aesthetic and ergonomic detail.

BM40

ARM Cortex A9 multicore based Book Mounting IPCs



The Book Mounting BM40 is based on the ARM Cortex A9 1GHz dual core processor (i.MX6 DualLite). The plastic case and the aluminium hooking system ensure a reliable fixing on a standard 35mm DIN rail.

The motherboard provides, on the front, one 10/100/1000 Mbps and one 100 Mbps Ethernet ports, two USB 2.0 ports, one RS232/485 serial port, a DVI-D video output and the signaling LEDs. The motherboard also provides an

internal slot for a removable MicroSD memory card, 4GB pseudo-SLC eMMC memory and 1 GB DDR3 RAM. BM40 has an isolated 24 VDC power supply input.

Gallery

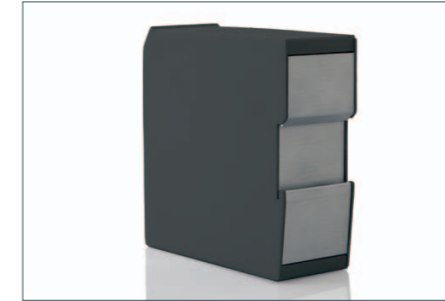

Technical data

		BM40
O.S. CERTIFIED	Installation	Microsoft Windows Embedded Compact 7 Pro with Datalight Reliance Nitro file system
	Material	Embedded Linux distribution based on Yocto Project
PROCESSOR		ARM Cortex A9 1 GHz i.MX6 DualLite
SYSTEM MEMORY - RAM		1 GB with DDR3 soldered
MASS STORAGE		4 GB eMMC Pseudo-SLC (Solid State Disk) 8bit, file system organization 1 x microSD slot internal access (FAT file system)
LAN		1 x 100 Mbps (RJ45); 1 x 10/100/1000 Mbps (RJ45 - Intel 82574L)
USB		2 x USB 2.0 (Type-A)
SERIAL		1 x RS232/485 isolated (DB15M)
BATTERY		1 x CR2032 Removable (internal)
VIDEO OUTPUT		1 x DVI-D
POWER SUPPLY INPUT		24VDC (18÷36VDC) isolated
CASE	Installation	For book mounting on DIN rail guide
	Material	Aluminium frame and hook, plastic shell
OPERATING TEMPERATURE		0°C÷50°C
APPROVALS		CE, cULus LISTED (61010)



+ Highlights

- Ubiquity remote assistance software providing remote access to the system
- ARM Cortex A9 i.MX6 DualLite processor
- Fanless ARM based book mounting IPC with 0°C÷50°C operating temperature
- Isolated 24 VDC power supply input
- CE, cULus LISTED (61010) certifications

BM1xx Family [new]

Ultra-compact book mounting IPC based on Intel® Apollo Lake™ platform



The ultra-compact Book Mounting family fanless IPC BM100 features a robust and elegant aluminium chassis and they are suitable for wall or DIN rail installation for applications

with limited space and that require high computing capacity for the processing of collected data in many Industrial IoT scenarios. BM1xx have an isolated 24

VDC power supply input, also with integrated UPS with external battery pack and they are available with different interfaces.

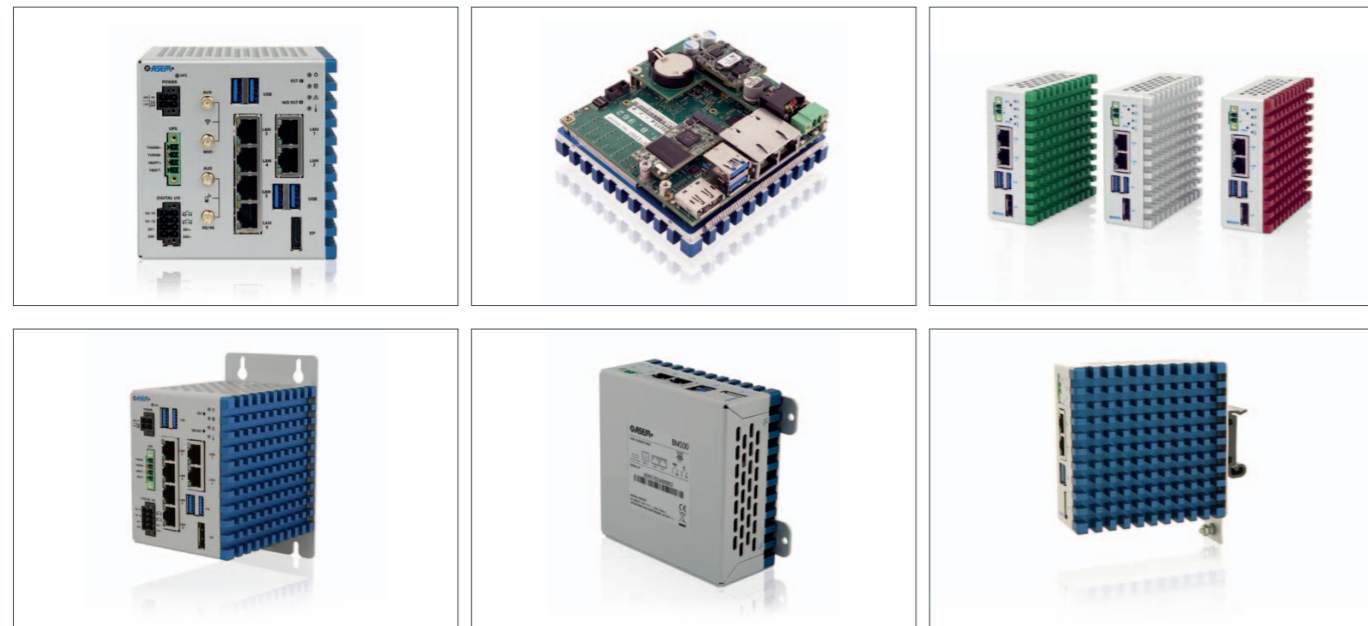

BM100



The Book Mounting BM100 is based on the Intel® Atom™ x5-3930 1.3GHz (1.80GHz Burst) or x7-3950 1.6GHz (2.00GHz Burst) processors of the Intel® Apollo Lake™ System On Chip (SoC) platform. The motherboard provides

two 10/100/1000Mbps ports, two USB 3.0 ports and a Display Port V1.2 video output with external access, a SATA III interface with M.2 key B connector for M.2 size 2242 SSD and 2GB, 4GB or 8GB soldered LP-DDR4 RAM. BM100 has an isolated 24

VDC power supply input and allows several wall mounting or DIN rail installation modes.



+ Highlights

- UBIQUITY remote assistance software providing remote access to the system
- Compact design (100x100x39mm)
- "All in one" motherboard
- Intel® Apollo Lake™ SoC platform
- Fanless book mounting IPC with up to 0°C÷55°C operating temperature
- 24 VDC isolated power supply input
- CE, cULus LISTED (61010) certifications

BM110 [new]



The Book Mounting fanless IPCs BM110 are an ultra - compact systems based on Intel® Atom™ x5-3930 1.3GHz (1.8GHz Burst) and x7-E3950 1.6GHz (2.0GHz Burst) processors of the Intel® Apollo Lake™ System On Chip (SoC) platform. BM110 systems feature a robust and elegant aluminium chassis (100x100x58mm) and allow

book mounting and DIN rail installation mode. The "all in one" motherboard provides two Gigabit Ethernet ports, that support "Jumbo Frame" and "Wake on Lan" functionalities, two USB 3.0 ports, an M.2 2242 key B connector for a SATA III SSD, up to 8GB soldered LP-DDR4 RAM, two digital video input, two digital video output and

a Display port V1.2 video output. BM110 systems have an isolated 24 VDC power supply input and optionally an integrated UPS with external battery pack.



+ Highlights

- UBIQUITY remote assistance software providing remote access to the system
- Compact design (100x100x58mm)
- "All in one" motherboard
- Intel® Apollo Lake™ SoC platform
- Fanless book mounting IPC with up to 0°C÷50°C operating temperature
- 24 VDC isolated power supply input
- Integrated UPS with external battery pack (optional)
- CE, cULus LISTED (61010) certifications

BM120 / BM121 / BM122 [new]



The Book Mounting fanless IPCs BM120, BM121 and BM122 are ultra - compact systems based on Intel® Atom™ x5-3930 1.3GHz (1.8GHz Burst) and x7-E3950 1.6GHz (2.0GHz Burst) processors of the Intel® Apollo Lake™ System On Chip (SoC) platform. The systems feature a robust and elegant aluminium chassis (100x100x78mm) and allow book mounting and DIN rail

installation mode. The motherboard provides an M.2 2242 key B connector for a SATA III SSD and up to 8GB soldered LP-DDR4 RAM. BM120 system has four Gigabit Ethernet ports, that support "Jumbo Frame" and "Wake on Lan" functionalities, four USB 3.0 ports, a serial RS232/422/485 interface, two digital video input, two digital video output and a Display port V1.2 video output.

BM121 system has two Gigabit Ethernet ports, that support "Jumbo Frame" and "Wake on Lan" functionalities, a four ports Gigabit Ethernet switch, four USB 3.0 ports, two digital video input, two digital video output and a Display port V1.2 video output. BM122 system has two Gigabit Ethernet ports, that support "Jumbo Frame" and "Wake on Lan" functionalities, two USB 3.0 ports, two digital video

input, two digital video output, a Wi-Fi/Bluetooth interface, a 4G Global modem and a Display port V1.2 video output. BM120, BM121 and BM122 systems have an isolated 24 VDC power supply input and optionally an integrated UPS with external battery pack.



+ Highlights

- UBIQUITY remote assistance software providing remote access to the system
- Compact design (100x100x78mm)
- Intel® Apollo Lake™ SoC platform
- Fanless book mounting IPC with up to 0°C÷50°C operating temperature
- 24 VDC isolated power supply input
- 4 ports Gigabit Ethernet switch (BM121)
- Wi-Fi/Bluetooth interface and 4G Global modem (BM122)
- Integrated UPS with external battery pack (optional)
- CE, cULus LISTED (61010) certifications

BM130 / BM131 [new]



The Book Mounting fanless IPCs BM130 and BM131 are ultra - compact systems based on Intel® Atom™ x5-3930 1.3GHz (1.8GHz Burst) and x7-E3950 1.6GHz (2.0GHz Burst) processors of the Intel® Apollo Lake™ System On Chip (SoC) platform. The systems feature a robust and elegant aluminium chassis (100x100x100mm) and allow

book mounting and DIN rail installation mode. The motherboard provides an M.2 2242 key B connector for a SATA III SSD and up to 8GB soldered LP-DDR4 RAM. BM130 system has four Gigabit Ethernet ports, that support "Jumbo Frame" and "Wake on Lan" functionalities, four USB 3.0 ports, a serial RS232/422/485 interface, two

digital video input, two digital video output, a Display port V1.2 video output, a Wi-Fi/Bluetooth interface and a 4G Global modem. BM131 system has two Gigabit Ethernet ports, that support "Jumbo Frame" and "Wake on Lan" functionalities, a four ports Gigabit Ethernet switch, four USB 3.0 ports, two digital video input, two digital video

output, and a Display port V1.2 video output, a Wi-Fi/Bluetooth interface and a 4G Global modem. BM130 and BM131 systems have an isolated 24 VDC power supply input and optionally an integrated UPS with external battery pack.



Highlights

- UBIQUITY remote assistance software providing remote access to the system
- Compact design (100x100x100mm)
- Intel® Apollo Lake™ SoC platform
- Fanless book mounting IPC with up to 0°C÷50°C operating temperature
- 4 ports Gigabit Ethernet switch (BM131)
- Wi-Fi/Bluetooth interface and 4G Global modem
- 24 VDC isolated power supply input
- Integrated UPS with external battery pack (optional)
- CE, cULus LISTED (61010) certifications

Technical Data

		BM100	BM110	BM120	BM121	BM122	BM130	BM131
PROCESSOR (soldered)		Intel® Atom™ x5-E3930 1.3GHz (1.8GHz Burst), 2 cores / 2 threads, 2MB L2 cache, 14nm Intel® Atom™ x7-E3950 1.6GHz (2.0GHz Burst), 4 cores / 4 threads, 2MB L2 cache, 14nm						
CHIPSET		Intel® Apollo Lake - Included into processor chip (SoC)						
VIDEO CONTROLLER		Intel® HD Graphics 500 integrated in x5-E3930, 400/550MHz Intel® HD Graphics 505 integrated in x7-E3950, 500/650MHz						
SYSTEM MEMORY		with x5-E3930: 2GB or 4GB LP-DDR4 with x7-E3950: 4GB or 8GB LP-DDR4						
MASS STORAGE		1 x onboard connector of M.2 size 2242 key B SSD SATA III						
LAN	10/100/1000 Mbps LAN port	2 x RJ45 ports (2 x Intel® I210)	4 x RJ45 ports (4 x Intel® I210)	2 x RJ45 ports (2 x Intel® I210)	4 x RJ45 ports (4 x Intel® I210)	2 x RJ45 ports (2 x Intel® I210)	2 x RJ45 ports (2 x Intel® I210)	
	10/100/1000 Mbps Ethernet switch			1 x unmanaged (Intel® I210) 4 x RJ45 ports			1 x unmanaged (Intel® I210) 4 x RJ45 ports	
USB		2 x USB 3.0 (Type-A)	4 x USB 3.0 (Type-A)	2 x USB 3.0 (Type-A)	4 x USB 3.0 (Type-A)			
SERIAL		-	1 x RS232/422/485 (DB9M)	-	1 x RS232/422/485 (DB9M)		-	
WI-FI	Standard					IEEE 802.11 a/b/g/n + Bluetooth V4.0 LE/ V3.0+HS/ V2.1+EDR		
	Features					Client / Access Point mode (Wi-Fi)		
	Security					64/128-Abits WEP, WPA, WPA2		
	Rx Sensitivity					802.11a: -73dBm / 802.11g: -74dBm / 802.11n(2.4GHz): -72dBm@HT20, -69dBm@HT40 / 802.11n(5GHz): -69dBm@HT20, -68dBm@HT40 (Wi-Fi) <0.1% BER at -70dBm (Bluetooth)		
	Antenna					2 x RP-SMA-F		
CELLULAR NETWORK	Standard					2G/3G/4G LTE CAT4 Multiband up to 50Mbps upload / 150Mbps download		
	Antenna					1 x SMA-F connector		
	SIM					1x SIM card socket push-push type		
DIGITAL INPUT		-	2 x Digital input					
DIGITAL OUTPUT		-	2 x Digital output					
VIDEO OUTPUT		1 x Display Port V1.2 (no audio)						
POWER SUPPLY INPUT		24VDC (18÷32VDC) isolated						
POWER SUPPLY OPTIONS		-	Remote power up input Power status output					
CASE		Integrated UPS with external battery pack						
CASE	Installation	Book, wall or DIN rail mounting						
	Material	Aluminium Alloy						
	Dimensions	100x100x39mm	100x100x58mm	100x100x78mm		100x100x100mm		
O.S. CERTIFIED		Microsoft Windows 10 IoT Enterprise 2016/2019 64 bit						
OPERATING TEMPERATURE		0°÷50°C						
APPROVALS		CE, cULus LISTED (61010)						

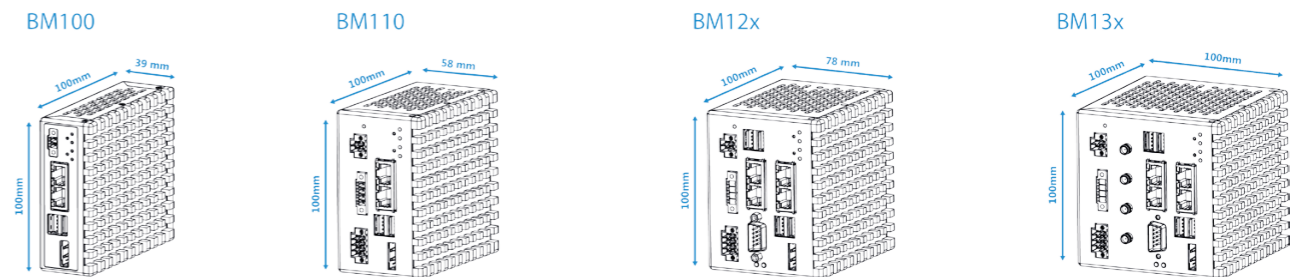

BM2150

Entry level Intel® Bay Trail™ based fanless book mounting IPCs



The Book Mounting fanless IPC BM2150 is an entry-level solution that offers an excellent performance/price ratio. It is based on the Celeron J1900 2GHz quad core 64 bit processor of the Intel® Bay Trail™ System On Chip (SoC) platform.

The "all in one" motherboard provides, on top, two Ethernet 10/100/1000Mbps ports, that support "Jumbo Frame" and "Wake on Lan" functionalities, one USB 3.0 port, one USB 2.0 port, a DVI-D video output and on front a SATA II CFast slot. The motherboard has also an mSATA connector for

SATA II SSD, up to 8 GB RAM with one DDR3 SODIMM module and an internal connector for additional interfaces. BM2150 system has an isolated 24 VDC power supply input and optionally an integrated UPS with external battery pack.



+ Highlights

- UBIQITY remote assistance software providing remote access to the system
- Support to 32 or 64 bit operating systems
- "All in one" motherboard
- High performance Intel® Bay Trail™ SoC platform
- Fanless book mounting IPC with 0°C÷50°C operating temperature
- Optional DIN rail mounting
- Isolated 24 VDC power supply input
- Integrated UPS with external battery pack (optional)
- Onboard connector for NETcore X fieldbus boards
- CE, cULus LISTED (61010) certifications

Gallery



Add-On boards

Position A

- 1 x RS232/422/485 + 1 x USB 2.0
- 1 x RS232/422/485 isol. + 1 x USB 2.0
- 2 x RS232
- 1 x USB 2.0
- 1 x NETcore X fieldbus board
- Wi-Fi/Bluetooth/Modem

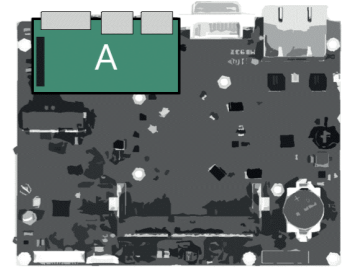

Technical data

		BM2150
PROCESSOR		Intel® Celeron J1900 2.00Ghz (2.42GHz Burst) a 64 bit, 4 cores / 4 threads, 2MB L2 cache, soldered
VIDEO CONTROLLER		Intel® HD Graphics integrated in microprocessor, 688MHz Clock 854MHz Turbo, LVDS 8bit/colour digital interface
SYSTEM MEMORY - RAM		1GB or 2GB or 4GB or 8GB (1 x SODIMM DDR3 module)
MASS STORAGE		1 bootable CFast SATA II slot onboard with front external access 1 x onboard connector for direct insertion of mSATA SSD SATA II
LAN		2 x LAN 10/100/1000Mbps top (RJ45 - 2 x Intel® I210)
USB		1 x USB 3.0 top (Type-A) 1 x USB 2.0 top (Type-A)
BATTERY		1 x CR2032 internal access
VIDEO OUTPUT		1 x DVI-D, top
ADD-ON INTERFACES (max 1)		1 x RS232/422/485 (DB15M) + 1 x USB 2.0 (Type-A)
		1 x RS232/422/485 (DB15M) isolated + 1 x USB 2.0 (Type-A)
		2 x RS232 (DB9M)
		1 x USB 2.0 (Type-A)
		1 x NETcore X fieldbus boards for EtherCAT, EtherNet IP, PROFINET, PROFIBUS, CANopen protocols
		1 x Wi-Fi/Bluetooth/Modem adapter
POWER SUPPLY INPUT		24VDC (18÷32VDC) isolated
POWER SUPPLY OPTIONS		UPS with external battery pack
		Kit for ATX mode power supply
CASE	Installation	For wall or DIN rail book mounting (optional)
	Material	Aluminium alloy 6082/5754/5056, Plastic front door
O.S. CERTIFIED		Microsoft Windows 7 Pro/Ultimate 32/64bit Microsoft Windows Embedded Standard 7E/7P 32/64 bit Microsoft Windows 8.1 Industry Pro 32/64bit Microsoft Windows 10 IoT Enterprise 2016/2019 64bit
OPERATING TEMPERATURE		0°C÷50°C
APPROVALS		CE, cULus LISTED (61010)

BM2200

Intel® Bay Trail™ based fanless book mounting IPCs



The Book Mounting fanless IPCs of the BM2200 family are based on the Celeron J1900 2.0GHz quad core 64 bit processor of the Intel® Bay Trail™ System On Chip (SoC) platform. BM2200 systems are supplied with a sturdy aluminum chassis, highly refined in every aesthetic and ergonomic detail. The "all in one" motherboard provides, on top, two

Ethernet 10/100/1000Mbps ports that support "Jumbo Frame" and "Wake on Lan" functionalities, two USB 2.0 ports, a DVI-I (DVI-D + VGA) video output or, as an alternative, a Remote Video Link connector (RJ45) for the remotation of the video and USB signals up to 100 m; on front, a USB 3.0 port, a slot for a SATA II CFast, a slot for the extractable system battery and the signalling LEDs. The

motherboard provides also an mSATA connector for a SATA II SSD, a SATA II connector for a 2.5" SSD/HDD, the possibility to install up to 8 GB RAM with one DDR3 SODIMM module and an internal connector for the installation of additional interfaces. BM2200 systems have an isolated 24 VDC power supply input and optionally an integrated UPS with external battery pack.



+ Highlights

- UBIQUITY remote assistance software providing remote access to the system
- Highly refined aluminium chassis
- Support to 32 or 64 bit operating systems
- "All in one" motherboard
- High performance Intel® Bay Trail™ SoC platform
- Fanless book mounting IPC with 0°C÷50°C operating temperature
- Isolated 24 VDC power supply input
- Integrated UPS with external battery pack (optional)
- RVL version (Remote Video Link) with remotation of DVI and USB 2.0 signals up to 100m
- CE, cULus LISTED (61010) certifications

Gallery



Technical data

	BM2200	BM2200 RVL
PROCESSOR (soldered)	Intel® Celeron J1900 2.00Ghz (2.42GHz Burst) a 64 bit, 4 cores / 4 threads, 2MB L2 cache	
VIDEO CONTROLLER	Intel® HD Graphics integrated in microprocessor, 688MHz Clock 854MHz Turbo, LVDS 8bit/colour digital interface	
SYSTEM MEMORY - RAM	1GB or 2GB or 4GB or 8GB (1 x SODIMM DDR3 module)	
TPM	TPM module (optional)	
MASS STORAGE	1 x bootable CFast SATA II slot onboard with front external access (front) 1 x onboard connector for direct insertion of mSATA SSD SATA II or 1 x onboard connector for 2,5" SSD/HDD SATA II with internal installation kit	
LAN	2 x LAN 10/100/1000Mbps (RJ45 - 2 x Intel® I210)	
USB	1 x USB 3.0, front (Type-A) 2 x USB 3.0, top (Type-A)	
BATTERY	1 x CR2032 Removable from the front	
VIDEO OUTPUT	1 x DVI-I top (DVI-D + VGA with adapter)	1 x RJ45 connector for the DVI-D and USB 2.0 signals remotation up to 100mt
ADD-ON INTERFACES (max 1)	1 x RS232/422/485 (DB15M) + 2 x RS232 (DB9M)	
	1 x RS232/422/485 (DB15M) isolated + 2 x RS232 (DB9M)	
	1 x RS232/422/485 (DB15M) + 1 x LAN 10/100/1000Mbps (RJ45 - Intel® I210)	
	1 x RS232/422/485 (DB15M) isolated + 1 x LAN 10/100/1000Mbps (RJ45 - Intel® I210)	
POWER SUPPLY INPUT	24VDC (18÷32VDC) isolated	
POWER SUPPLY OPTIONS	UPS with external battery pack	
CASE	Installation	Wall book mounting
	Material	Aluminium alloy 6082/5754/5056
O.S. CERTIFIED	Microsoft Windows 7 Pro/Ultimate 32/64 bit Microsoft Windows Embedded Standard 7E/7P 32/64 bit Microsoft Windows 8.1 Industry Pro 32/64 bit Microsoft Windows 10 IoT Enterprise 2016/2019 64 bit	
OPERATING TEMPERATURE	0°C÷50°C	
	0°C÷45°C with HDD 24x7	
APPROVALS	CE, cULus LISTED (61010)	

BM2250 [new]

Entry – level fanless book mounting IPCs based on Intel® Apollo Lake™ platform



The Book Mounting fanless IPC BM2250 is an entry-level solution that offers an excellent performance/price ratio. It is based on the Atom™ x5-3930 1.3GHz (1.80GHz Burst) or x7-3950 1.6GHz (2.00GHz Burst) processors of the Intel® Apollo Lake™ System on Chip (SoC) platform.

The "all in one" motherboard provides, on top, two Gigabit Ethernet ports, that support "Jumbo Frame" and "Wake on Lan" functionalities, three USB 3.0 ports, a Display Port Dual Mode video output and, on front, a SATA III CFAST slot. The motherboard has also a M.2 connector for a SATA III SSD, up to 8 GB LPDDR4 RAM

and an internal connector for additional interfaces. BM2250 system has an isolated 24 VDC power supply input and optionally an integrated UPS with external battery pack.



Highlights

- UBIQUITY remote assistance software providing remote access to the system
- "All in one" motherboard
- Intel® Apollo Lake™ SoC platform
- Fanless book mounting IPC with 0°C ÷ 50°C operating temperature
- Optional DIN rail mounting
- Isolated 24 VDC power supply input
- Integrated UPS with external battery pack (optional)
- Onboard connector for NETcore X fieldbus boards
- CE, cULus LISTED (61010) certifications

Gallery



Add-On boards

Position A

- 1 x RS232/422/485 + 1 x USB 2.0
- 1 x RS232/422/485 isol. + 1 x USB 2.0
- 2 x RS232/422/485
- 2 x RS232/422/485 isol.
- 2 x RS232
- 1 x LAN Gigabit + 1 x USB 2.0
- 2 x USB 2.0
- 1 x NETcore X fieldbus board
- Wireless/Bluetooth/Modem

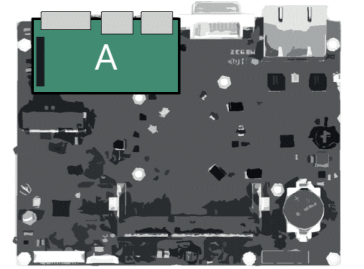

Technical data

		BM2250
PROCESSOR (soldered)		Intel® Atom™ x5-E3930 1.3GHz (1.8GHz Burst), 2 cores / 2 threads, 2MB L2 cache, 14nm Intel® Atom™ x7-E3950 1.6GHz (2.0GHz Burst), 4 cores / 4 threads, 2MB L2 cache, 14nm
CHIPSET		Intel® Apollo Lake - Included into processor chip (SoC)
VIDEO CONTROLLER		"Intel® HD Graphics 500 integrated in x5-E3930, 400/550MHz Intel® HD Graphics 505 integrated in x7-E3950, 500/650MHz
SYSTEM MEMORY RAM (soldered)		
	with x5-E3930	4GB LP-DDR4
	with x7-E3950	4GB or 8GB LP-DDR4
MASS STORAGE		1 bootable CFAST SATA II slot onboard with front external access 1 x onboard connector for M.2 2242 SATAIII SSD
LAN		2 x Gigabit Ethernet top (RJ45 - 2 x Intel® I210-AT)
USB		3 x USB 3.0 top (Type-A)
BATTERY		1 x CR2032 internal access
VIDEO OUTPUT		1 x Display Port V1.2 (no audio)
ADD-ON INTERFACES		1 x RS232/422/485 (DB15M)+ 1 x USB 2.0 (Type-A) 1 x RS232/422/485 (DB15M) isolated + 1 x USB 2.0 (Type-A) 2 x RS232/422/485 (DB9M) 2 x RS232/422/485 (DB9M) isolated 2 x RS232 (DB9M) 2 x USB 2.0 (Type-A) 1 x Gigabit Ethernet (RJ45 - Intel® I210) + 1 x USB 2.0 (Type-A) 1 x NETcore X fieldbus boards for EtherCAT, EtherNet IP, PROFINET, PROFIBUS, CANopen protocols
POWER SUPPLY INPUT		1 x Wireless/Bluetooth/Modem adapter 24VDC (18÷32VDC) isolated
POWER SUPPLY OPTIONS		UPS with external battery pack Kit for ATX mode power supply
CASE	Installation Material	For wall or DIN rail book mounting (optional) Aluminium alloy 6082/5754/5056, Plastic front door
O.S. CERTIFIED		Microsoft Windows 10 IoT Enterprise 2016/2019 64bit
OPERATING TEMPERATURE		0°C ÷ 50°C
APPROVALS		CE, cULus LISTED (61010)

BM3300 / BM3500

Intel® Skylake™ U and Kaby Lake™ U based fanless book mounting IPCs



The fanless Book Mounting IPC family BM3300 is based on the 6th generation Core i3, i5, i7 and Celeron dual core 15W processors of the Intel® Skylake™ U and the BM3500 family is based on the 7th generation Core i3, i5, i7 and Celeron dual core 15W processors of the Intel® Kaby Lake™ U platform. The systems are supplied with a sturdy aluminum chassis, highly refined in every

aesthetic and ergonomic detail. The "all in one" motherboard provides, on top, three Ethernet 10/100/1000Mbps ports that support "Jumbo Frame" and "Wake on Lan" functionalities, two USB 3.0 ports and one DVI-D video output or, as an alternative, a Remote Video Link connector (RJ45) for the remotation of the video and USB signals up to 100

m; on front, a USB 3.0 port, a SATA III CFast slot, a slot for the extractable system battery and the signalling LEDs. The motherboard has also an mSATA connector for a SATA III SSD, one SATA III connector for a 2.5" SSD/HDD, up to 16 GB RAM with one DDR4 SODIMM module and an internal connector for additional interfaces. The systems have an isolated 24 VDC power supply input

and optionally an integrated UPS with external battery pack.



+ Highlights

- UBIQUITY remote assistance software providing remote access to the system
- Highly refined aluminium chassis
- "All in one" motherboard
- Low consumption Intel® Skylake™ U (BM3300) and Kaby Lake™ U (BM3500) platforms
- Fanless book mounting IPC with 0°C÷50°C operating temperature
- Isolated 24 VDC power supply input
- Onboard connector for NETcore X fieldbus boards
- Integrated UPS with external battery pack (optional)
- RVL version (Remote Video Link) with remotation of DVI and USB 2.0 signals up to 100 m
- CE, cULus LISTED (61010) certifications

Gallery



Add-On boards

Position A

- 1 x RS232/422/485 + 1 x USB 2.0
- 1 x RS232/422/485 isol. + 1 x USB 2.0
- 2 x RS232
- 2 x USB 2.0
- 1 x NETcore X fieldbus board

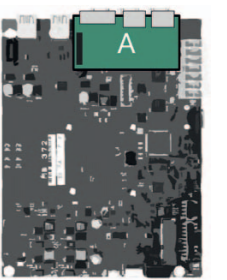

Technical data

	BM3300/BM3500	BM3300 RVL/BM3500 RVL
PROCESSORS (soldered)	BM3300 Intel® Celeron 3955U 2.00GHz 64bit, 2 cores / 2 threads, 2MB Smart cache Intel® Core i3-6100U 2.30GHz 64bit, 2 cores / 4 threads, 3MB Smart cache Intel® Core i5-6300U 2.40GHz (3.00GHz Turbo) 64bit, 2 cores / 4 threads, 3MB Smart cache Intel® Core i7-6600U 2.60GHz (3.40GHz Turbo) 64bit, 2 cores / 4 threads, 4MB Smart cache	BM3500 Intel® Celeron 3965U 2.20GHz 64bit, 2 cores / 2 threads, 2MB Smart cache Intel® Core i3-7100U 2.40GHz 64bit, 2 cores / 4 threads, 3MB Smart cache Intel® Core i5-7300U 2.60GHz (3.50GHz Turbo) 64bit, 2 cores / 4 threads, 3MB Smart cache Intel® Core i7-7600U 2.80GHz (3.90GHz Turbo) 64bit, 2 cores / 4 threads, 4MB Smart cache
CHIPSET	BM3300 Intel® Skylake U PCH (Platform Controller Hub) for BM3300 • Included into processor chip	BM3500 Intel® Kaby Lake U PCH (Platform Controller Hub) for BM3500 • Included into processor chip
VIDEO CONTROLLER	BM3300 Intel® HD Graphics 510 integrated in Celeron processor • 300MHz/900MHz • DirectX 12 and OpenGL 4.4 support Intel® HD Graphics 520 integrated in Core i3, Core i5 processors • 300MHz/1GHz • DirectX 12 and OpenGL 4.4 support Intel® HD Graphics 520 integrated in Core i7 processor • 300MHz/1,05GHz • DirectX 12 and OpenGL 4.4 support	BM3500 Intel® HD Graphics 620 integrated in Core i3 processors • 300MHz/1GHz • DirectX 12 and OpenGL 4.5 support Intel® HD Graphics 620 integrated in Core i5 processors • 300MHz/1.1GHz • DirectX 12 and OpenGL 4.5 support Intel® HD Graphics 620 integrated in Core i7 processor • 300MHz/1.15GHz • DirectX 12 and OpenGL 4.5 support
SYSTEM MEMORY - RAM	4GB or 8GB or 16GB (1 x SODIMM DDR4 module)	
TPM	TPM module (optional)	
MASS STORAGE	1 bootable CFast SATA III slot onboard with external access (front) 1 x onboard connector for direct insertion of mSATA SSD SATA III 1 x onboard connector for 2,5" SSD/HDD SATA III with internal installation kit	
LAN	3 x LAN 10/100/1000Mbps (RJ45 - 2 x Intel® I210, 1 x Intel® I219LM)	
USB	1 x USB 3.0, front (Type-A) 2 x USB 3.0, top (Type-A)	
BATTERY	1 x CR2032 Removable front access	
VIDEO OUTPUT	1 x DVI-D	1 x RJ45 connector for the DVI-D and USB 2.0 signals emotation up to 100 m
ADD-ON INTERFACES	1 x RS232/422/485 (DB15M) + 1 x USB 2.0 (Type-A) 1 x RS232/422/485 (DB15M) isolated + 1 x USB 2.0 (Type-A) Position A (max 1) 2 x RS232 (DB9M) 2 x USB 2.0 (Type-A) 1 x LAN 10/100/1000Mbps (RJ45 - Intel® I210) + 1 x USB 2.0 (Type-A) 1 x NETcore X fieldbus boards for EtherCAT, EtherNet IP, PROFINET, PROFIBUS, CANopen protocols	
POWER SUPPLY INPUT	24VDC (18÷32VDC) isolated	
POWER SUPPLY OPTIONS	UPS with external battery pack	
CASE	Installation	Wall book mounting
	Material	Aluminium alloy 6082/5754/5056
O.S. CERTIFIED	BM3300	Microsoft Windows 7 Pro/Ultimate 32/64bit Microsoft Windows Embedded Standard 7E/7P 32/64 bit Microsoft Windows 8.1 Industry Pro 32/64bit Microsoft Windows 10 IoT Enterprise 2016/2019 64bit
	BM3500	Microsoft Windows 10 IoT Enterprise 2016/2019 64bit
OPERATING TEMPERATURE	0°C÷50°C 0°C÷45°C with HDD 24x7	
APPROVALS	CE, cULus LISTED (61010)	

BM3400 / BM3600

Intel® Skylake™ H and Kaby Lake™ H based fanless book mounting IPCs



The fanless Book Mounting IPC family BM3400 is based on the 6th generation Core i3, i5, i7 and Celeron of the Intel® Skylake™ H and the BM3600 family is based on the 7th generation Core i3, i5, i7 of the Intel® Kaby Lake™ H platform. The systems are supplied with a sturdy aluminum chassis, highly refined in every aesthetic and ergonomic detail. The "all in one" motherboard provides, on top, four Ethernet

10/100/1000Mbps ports, that support "Jumbo Frame" and "Wake on Lan" functionalities, two USB 3.0 ports, two USB 2.0 ports, a serial RS232 interface and one DVI-D video output; on front, a USB 3.0 port, a SATA III CFast slot, a slot for the extractable system battery, the signalling LEDs and optionally two slots for extractable storage units drawers. The motherboard has also an mSATA connector for a SATA III SSD, two SATA

III connector for 2.5" SSDs/HDDs, the possibility to set the mass storage devices in RAID 0, 1 configuration, up to 32 GB RAM with two DDR4 SODIMM modules and two internal connectors for additional interfaces, including the remotation of the video and USB signals up to 100m (Remote Video Link). BM3400 and BM3600 systems have an isolated 24 VDC power supply input and optionally an integrated UPS

with external battery pack. The systems are available in two versions, the S0 with the possibility to install additional interfaces, the S2 and the S3 with respectively two and three PCI or PCIe expansion slots. Optionally a forced ventilation kit is available to ensure 0°C÷50°C operating temperature with Core i7 processor or expansions cards with a maximum total consumption of 20W.



Highlights

- UBIQUITY remote assistance software providing remote access to the system
- Highly refined aluminium chassis
- Extractable drawers for 2.5" storage devices
- RAID 0,1
- Up to 2 Remote Video Link - remotation of DVI and USB 2.0 signals up to 100m
- "All in one" motherboard
- High performance Intel® Skylake™ H and Kaby Lake™ H platforms
- Fanless book mounting IPC with 0°C÷50°C operating temperature
- Isolated 24 VDC power supply input
- Onboard connector for NETcore X fieldbus boards
- Integrated UPS with external battery pack (optional)
- S2 version with two PCI or PCIe 4x expansion slots
- CE, cULus LISTED (61010) certifications

Gallery



Add-On boards

Position A

- 1 x RS232/422/485 + 1 x USB 2.0
- 1 x RS232/422/485 isol. + 1 x USB 2.0
- 2 x RS232
- 2 x USB 2.0
- 1 x NETcore X fieldbus board

Position B

- 1 x RJ45 Remote Video Link (RVL OUT)
- 2 x RJ45 Remote Video Link (RVL OUT)

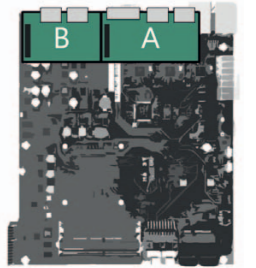

Technical data

		BM3400/BM3600
PROCESSORS	BM3400	Intel® Celeron G3900E 2.40GHz 64bit, 2 cores / 2 threads, 2MB Smart cache Intel® Core i3-6100E 2.70GHz 64bit, 2 cores / 4 threads, 3MB Smart cache Intel® Core i5-6440EQ 2.70GHz (3.40GHz Turbo) 64bit, 4 cores / 4 threads, 6MB Smart cache Intel® Core i7-6820EQ 2.80GHz (3.50GHz Turbo) 64bit, 4 cores / 8 threads, 8MB Smart cache
	BM3600	Intel® Core i3-7100E 2.90GHz 64bit, 2 cores / 4 threads, 3MB Smart cache Intel® Core i5-7440EQ 2.90GHz (3.60GHz Turbo) 64bit, 4 cores / 4 threads, 6MB Smart cache Intel® Core i7-7820EQ 3.00GHz (3.70GHz Turbo) 64bit, 4 cores / 8 threads, 8MB Smart cache
	CHIPSET	BM3400 Intel® HM170 PCH (Platform Controller Hub) BM3600 Intel® HM175 PCH (Platform Controller Hub)
S2/S3 versions with 2x PCIe x4		Intel® CM236 PHC (Platform Controller Hub)
VIDEO CONTROLLER	BM3400	Intel® HD Graphics 510 integrated in Celeron processor • 350MHz/950MHz • DirectX 12 and OpenGL 4.4 support Intel® HD Graphics 530 integrated in Core i3 processor • 350MHz/950MHz • DirectX 12 and OpenGL 4.4 support Intel® HD Graphics 530 integrated in Core i5, Core i7 processors • 350MHz/1,00GHz • DirectX 12 and OpenGL 4.4 support
	BM3600	Intel® HD Graphics 630 integrated in Core i3 processor • 350MHz/950MHz • DirectX 12 and OpenGL 4.5 support Intel® HD Graphics 630 integrated in Core i5, Core i7processors • 350MHz/1,00GHz • DirectX 12 and OpenGL 4.5 support
SYSTEM MEMORY - RAM		4GB (1 x SODIMM DDR4 module) or 8GB or 16GB or 32GB (2 x SODIMM DDR4 modules)
TPM		TPM module (optional)
MASS STORAGE	S0	1 x bootable CFast SATA III slot onboard with external access 1 x onboard connector for direct insertion of mSATA SSD SATA III w/o RVL: onboard connectors for 1 x SSD/HDD 2.5" SATA III with internal installation kit or max 2 x SSDs/HDDs 2.5" SATA III with front extractable drawers with RVL: onboard connector for 1 x SSD/HDD 2.5" SATA III with internal installation kit or with front extractable drawer
	S2/S3	1 x bootable CFast SATA III slot onboard with external access 1 x onboard connector for direct insertion of mSATA SSD SATA III 2 x onboard connectors for SSDs/HDDs 2.5" SATA III with internal installation kit or with front extractable drawers
LAN		4 x LAN 10/100/1000Mbps top (RJ45 - 3 x Intel® I210 + 1 x Intel® I219LM)
USB		1 x USB 3.0 front (Type-A) 2 x USB 2.0 top (Type-A) + 2 x USB 3.0 top (Type-A)
SERIAL		1 x RS232 (DB9M)
BATTERY		1 x CR2032 Removable front access
VIDEO OUTPUT		1 x DVI-D, top 1 or 2 x RJ45 connectors Remote Video Link (DVI-D and USB 2.0 signals remotation up to 100 m, optional)
ADD-ON INTERFACES		1 x RS232/422/485 (DB15M) + 1 x USB 2.0 (Type-A)
		1 x RS232/422/485 (DB15M) isolated + 1 x USB 2.0 (Type-A)
	Position A (max 1)	2 x RS232 (DB9M) 2 x USB 2.0 (Type-A) 1 x NETcore X fieldbus boards for EtherCAT, EtherNet IP, PROFINET, PROFIBUS, CANopen protocols
	Position B (max 1)	1 x connector Remote Video Link (RJ45 - RVL OUT) 2 x connectors Remote Video Link (RJ45 - RVL OUT)
EXPANSION SLOTS	S2	2 x PCIe x4 or 1 x PCI + 1 x PCIe x4, max 10W total
	S3	2 x PCIe x4 + 1 x PCIe x1, max 10W total
VENTILATION (optional)		Forced ventilation kit for 0°C÷50°C operating temperature with Core i7 processor or expansion card with max 20W total
POWER SUPPLY INPUT		24VDC (18÷32VDC) isolated
POWER SUPPLY OPTIONS		UPS with external battery pack Kit for ATX mode power supply
CASE	Installation	For book mounting
	Material	Aluminium Alloy 6082/5754/5056
O.S. CERTIFIED		Microsoft Windows 7 Pro/Ultimate 32/64bit Microsoft Windows Embedded Standard 7E/7P 32/64 bit Microsoft Windows 10 IoT Enterprise 2016/2019 64bit
	BM3400	Microsoft Windows 10 IoT Enterprise 2016/2019 64bit
	BM3600	Microsoft Windows 10 IoT Enterprise 2016/2019 64bit
OPERATING TEMPERATURE		without forced ventilation: 0°C÷50°C, 0°C÷45°C with HDD 24x7 or Core i7 with forced ventilation: 0°C÷50°C, 0°C÷45°C with HDD 24x7
APPROVALS		CE, cULus LISTED (61010)

Box IPCs

ASEM provides a full range of Box IPCs in terms of configurability, dimensions and performances. They are based on Celeron, Core™ i3, i5, i7 dual and quad core processors of the Intel® Bay Trail™, Broadwell™, Skylake™ and Kaby Lake™ platforms, and they are suitable for wall or DIN rail mounting.



PB2150

Intel® Bay Trail™ based fanless box IPCs



The fanless box IPC family PB2150 is an entry-level system that offers an excellent performance/price ratio. It is based on the Celeron J1900 2GHz quad core 64 bit processor of the Intel® Bay Trail™ System On Chip (SoC) platform. The "all in one" motherboard provides two Ethernet 10/100/1000Mbps ports, that

support "Jumbo Frame" and "Wake on Lan" functionalities, a USB 3.0 port, a USB 2.0 port, a DVI-D video output and a SATA II CFast slot with external access, an mSATA connector for SATA II SSD, up to 8 GB RAM with one DDR3 SODIMM module and an internal connector for additional interfaces.

PB2150 systems have an isolated 24 VDC power supply input and optionally an integrated UPS with external battery pack. The systems are available in two versions, the SL with a reduced depth and the S0 with the possibility to install additional interfaces.



+ Highlights

- UBIQUITY remote assistance software providing remote access to the system
- Support to 32 or 64 bit operating systems
- "All in one" motherboard
- High performance Intel® Bay Trail™ SoC platform
- Fanless box IPC with 0°C÷50°C operating temperature
- Isolated 24 VDC power supply input
- Onboard connector for NETcore X fieldbus boards
- Integrated UPS with external battery pack (optional)
- SL version with reduced depth
- CE, cULus LISTED (61010) certifications

Gallery



Add-On boards

Position A

- 1 x RS232/422/485 + 1 x USB 2.0
- 1 x RS232/422/485 isol. + 1 x USB 2.0
- 2 x RS232
- 1/2 x USB 2.0
- 1 x LAN Gigabit + 1 x USB 2.0
- 1 x NETcore X fieldbus board
- Wi-Fi/Bluetooth/Modem



Technical data

	PB2150
PROCESSOR	Intel® Celeron® Processor J1900 2.00GHz (2.42GHz Burst) a 64 bit, 4 cores / 4 threads, 2MB L2, 22nm technology
VIDEO CONTROLLER	Intel® HD Graphics integrated in microprocessor, 688MHz Clock 854MHz Turbo, LVDS 8bit/colour digital interface
SYSTEM MEMORY - RAM	1GB or 2GB or 4GB or 8GB (1 x SODIM DDR3 module)
MASS STORAGE	1 bootable CFast SATA II slot onboard with external access 1 x onboard connector for direct insertion of mSATA SSD SATA II
LAN	2 x LAN 10/100/1000Mbps (RJ45 - 2 x Intel® I210)
USB	1 x USB 3.0 rear (Type-A) 1 x USB 2.0 rear (Type-A)
VIDEO OUTPUT	1 x DVI-D
ADD-ON INTERFACES (only for S0, max 1)	1 x RS232/422/485 (DB15M) + 1 x USB 2.0 (Type-A)
	1 x RS232/422/485 (DB15M) isolated + 1 x USB 2.0 (Type-A)
	2 x RS232 (DB9M)
	1 x USB 2.0 (Type-A)
	2 x USB 2.0 (Type-A)
	1 x LAN 10/100/1000Mbps (RJ45 - Intel®I210) + 1 x USB 2.0
	1 x NETcore X fieldbus boards for EtherCAT, EtherNet IP, PROFINET, PROFIBUS, CANopen protocols
	1 x Wi-Fi/Bluetooth/Modem adapter
POWER SUPPLY INPUT	24VDC (18÷32VDC) isolated
POWER SUPPLY OPTIONS	UPS with external battery pack Kit for ATX mode power supply
O.S. CERTIFIED	Microsoft Windows 7 Pro/Ultimate 32/64 bit, Microsoft Windows Embedded Standard 7E/7P 32/64 bit, Microsoft Windows 8.1 Industry Pro 32/64 bit, Microsoft Windows 10 IoT Enterprise 2016/2019 64 bit
OPERATING TEMPERATURE	0°C÷50°C
APPROVALS	CE, cULus LISTED (61010)

PB2200

Intel® Bay Trail™ based fanless box IPCs



The fanless box IPC family PB2200 is based on the Celeron J1900 2GHz quad core 64 bit processor of the Intel® Bay Trail™ System On Chip (SoC) platform. The "all in one" motherboard provides two Ethernet 10/100/1000Mbps ports, that support "Jumbo Frame" and "Wake on Lan" functionalities, one USB 3.0 port, two USB 2.0

ports, a serial RS232 interface, a DVI-I (DVI-D + VGA) video output and a SATA II CFast slot with external access, an mSATA connector for SATA II SSD, one SATA II connector for the installation of 2.5" HDD/SSD, up to 8 GB RAM with one DDR3 SODIMM module and two internal connectors for additional interfaces.

PB2200 systems have an isolated 24 VDC power supply input and optionally an integrated UPS with external battery pack. The systems are available in three versions, the SL with a reduced depth, the S0 with the possibility to install additional interfaces and the S1 with a PCI or PCIe x1 slot.



Highlights

- UBIQUITY remote assistance software providing remote access to the system
- Support to 32 or 64 bit operating systems
- "All in one" motherboard
- High performance Intel® Bay Trail™ SoC platform
- Fanless box IPC with 0°C÷50°C operating temperature
- Isolated 24 VDC power supply input
- Onboard connector for NETcore X fieldbus boards
- Integrated UPS with external battery pack (optional)
- SL version with reduced depth
- S1 version with one PCI or PCIe x1 expansion slot
- CE, cULus LISTED (508) certifications

Gallery



Add-On boards

Position A

- 1 x RS232/422/485 + 1 x USB 2.0
- 1 x RS232/422/485 isol. + 1 x USB 2.0
- 2 x RS232
- 2 x USB 2.0

Position B

- 1 x LAN Gigabit
- 1 x NETcore X fieldbus board
- Wi-Fi/Bluetooth/Modem

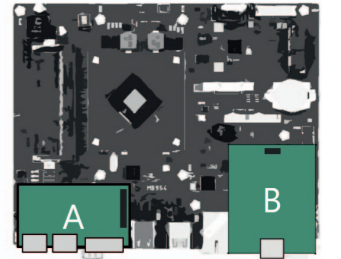

Technical data

	PB2200
PROCESSOR	Intel® Celeron J1900 2.0Ghz (2.42Ghz Burst) 64 bit, 4 cores / 4 threads, 2MB L2 cache, soldered
VIDEO CONTROLLER	Intel® HD Graphics integrated in microprocessor, 688MHz Clock 854MHz Turbo, LVDS 8bit/colour digital interface
SYSTEM MEMORY - RAM	1GB or 2GB or 4GB or 8GB (1 x SODIMM DDR3 module)
MASS STORAGE	1 bootable CFast SATA II slot onboard with external access 1 x onboard connector for direct insertion of mSATA SSD SATA II
SL/S0/S1	1 x bootable CFast SATA II slot on board with external access 1 x onboard connector for 2,5" SSD/HDD 24x7 SATA II with internal installation kit
LAN	2 x LAN 10/100/1000Mbps (RJ45 - 2 x Intel® I210)
USB	1 x USB 3.0 rear (Type-A) 2 x USB 2.0 rear (Type-A)
SERIAL	1 x RS232 (DB9M)
VIDEO OUTPUT	1 x DVI-I (DVI-D + VGA with adapter)
ADD-ON INTERFACES (only for S0/S1)	1 x RS232/422/485 (DB15M)+ 1 x USB 2.0 (Type-A) 1 x RS232/422/485 (DB15M) isolated + 1 x USB 2.0 (Type-A)
Position A (max 1)	2 x RS232 (DB9M) 2 x USB 2.0 (Type-A)
Position B (max 1)	1 x LAN 10/100/1000Mbps (RJ45 - Intel® I210) 1 x NETcore X fieldbus boards for EtherCAT, EtherNet IP, PROFINET, PROFIBUS, CANopen protocols 1 x Wi-Fi/Bluetooth/Modem adapter
EXPANSION SLOTS S1	1 x PCI / PCIe x1
POWER SUPPLY INPUT	24VDC (18÷32VDC) isolated
POWER SUPPLY OPTIONS	UPS with external battery pack Kit for ATX mode power supply
O.S. CERTIFIED	Microsoft Windows 7 Pro/Ultimate 32/64 bit Microsoft Windows Embedded Standard 7E/7P 32/64 bit Microsoft Windows 8.1 Industry Pro 32/64 bit Microsoft Windows 10 IoT Enterprise 2016/2019 64 bit
OPERATING TEMPERATURE	0°C÷50°C 0°C÷45°C with 24x7 HDD
APPROVALS	CE, cULus LISTED (508)

PB2250 [new]

Entry-level compact box IPCs based on Intel® Apollo Lake™ platform



The fanless Box IPC family PB2250 is based on the Intel® Atom™ x5-3930 1.3GHz (1.80GHz Burst) or x7-3950 1.6GHz (2.00GHz Burst) processors of the Intel® Apollo Lake™ System on Chip (SoC) platform. The "all in one" motherboard provides two Gigabit Ethernet

ports, that support "Jumbo Frame" and "Wake on Lan" functionalities, three USB 3.0 ports, a Display Port dual mode video output, a SATA III CFast slot with rear external access, an M.2 connector for a SATA III SSD, up to 8 GB RAM LPDDR4 and one internal connector for additional interfaces.

PB2250 systems have an isolated 24 VDC power supply input and optionally an integrated UPS with external battery pack. The systems are available in two versions, the SL with a reduced depth and the S0 with the possibility to install additional interfaces.



+ Highlights

- UBIQUITY remote assistance software providing remote access to the system
- Intel® Apollo Lake™ SoC platform
- "All in one" motherboard
- Fanless box IPC with 0°C÷50°C operating temperature
- Isolated 24 VDC power supply input
- Integrated UPS with external battery pack (optional)
- Onboard connector for NETcore X fieldbus boards
- SL version with reduced depth
- CE, cULus LISTED (61010) certifications

Gallery



Add-On boards

Position A

- 1 x RS232/422/485 + 1 x USB 2.0
- 1 x RS232/422/485 isol. + 1 x USB 2.0
- 2 x RS232/422/485
- 2 x RS232/422/485 isol.
- 2 x RS232
- 1 x LAN Gigabit + 1 x USB 2.0
- 2 x USB 2.0
- 1 x NETcore X fieldbus board
- Wireless/Bluetooth/Modem

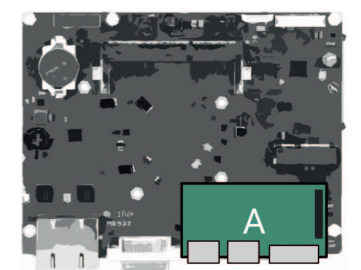

Technical data

PB2250	
PROCESSOR	Intel® Atom™ x5-E3930 1.3GHz (1.8GHz Burst), 2 cores / 2 threads, 2MB L2 cache, 14nm Intel® Atom™ x7-E3950 1.6GHz (2.0GHz Burst), 4 cores / 4 threads, 2MB L2 cache, 14nm
CHIPSET	Intel® Apollo Lake - Included into processor chip (SoC)
VIDEO CONTROLLER	Intel® HD Graphics 500 integrated in x5-E3930, 400/550MHz Intel® HD Graphics 505 integrated in x7-E3950, 500/650MHz
SYSTEM MEMORY RAM (SOLDERED)	4GB LP-DDR4 with x5-E3950 4GB or 8GB LP-DDR4 with x7-E3950
MASS STORAGE	"1 x bootable CFast SATA III slot onboard with external access 1 x onboard connector for direct insertion of M.2 SATA III SSD"
LAN	2 x LAN 10/100/1000Mbps (RJ45 - 2 x Intel® I210)
USB	3 x USB 3.0 rear (Type-A)
VIDEO OUTPUT	1 x Display Port V1.2
ADD-ON INTERFACES (only for S0, max 1)	1 x RS232/422/485 (DB15M) + 1 x USB 2.0 (Type-A)
	1 x RS232/422/485 (DB15M) isolated + 1 x USB 2.0 (Type-A)
	2 x RS232/422/485 (DB9M)
	2 x RS232/422/485 (DB9M) isolated
	2 x RS232 (DB9M)
	2 x USB 2.0 (Type-A)
	1 x LAN 10/100/1000Mbps (RJ45 - Intel® I210) + 1 x USB 2.0
	1 x NETcore X fieldbus boards for EtherCAT, EtherNet IP, PROFINET, PROFIBUS, CANopen protocols
	1 x Wireless/Bluetooth/Modem adapter
POWER SUPPLY INPUT	24VDC (18÷32VDC) isolated
POWER SUPPLY OPTIONS	"UPS with external battery pack Kit for ATX mode power supply"
O.S. CERTIFIED	Microsoft Windows 10 IoT Enterprise 2016/2019 64 bit
OPERATING TEMPERATURE	0°C÷50°C
APPROVALS	CE, cULus LISTED (61010)

PB3200

Intel® Broadwell™ U based fanless box IPCs



The fanless box IPC family PB3200 is based on the fifth generation Core i3, i5, i7 and Celeron of the Intel® Broadwell™ U platform. The "all in one" motherboard provides three Ethernet 10/100/1000Mbps ports, that support "Jumbo Frame" and "Wake on Lan" functionalities, two USB 3.0 ports, one USB 2.0 port, a serial RS232

interface, a DVI-I (DVI-D + VGA) video output and a SATA III CFast slot with external access, an mSATA connector for SATA III SSD, one SATA III connector for the installation of 2.5" HDD/SSD, up to 16 GB RAM with one DDR3 SODIMM module and two internal connectors for additional interfaces.

PB3200 systems have an isolated 24 VDC power supply input and optionally an integrated UPS with external battery pack. The systems are available in three versions, the SL with a reduced depth, the S0 with the possibility to install additional interfaces and the S1 with a PCI or PCIe x4 slot.



+ Highlights

- UBIQUITY remote assistance software providing remote access to the system
- "All in one" motherboard
- 15W processors - Intel® Broadwell™ U platform
- Fanless box IPC with 0°C ÷ 50°C operating temperature
- Isolated 24 VDC power supply input
- Onboard connector for NETcore X fieldbus boards
- Integrated UPS with external battery pack (optional)
- SL version with reduced depth
- S1 version with one PCI or PCIe x4 expansion slot
- CE, cULus LISTED (61010) certifications

Gallery



Add-On boards

Position A

- 1 x RS232/422/485 + 1 x USB 2.0
- 1 x RS232/422/485 isol. + 1 x USB 2.0
- 2 x RS232
- 2 x USB 2.0

Position B

- 1 x LAN Gigabit
- 1 x NETcore X fieldbus board
- Wi-Fi/Bluetooth/Modem

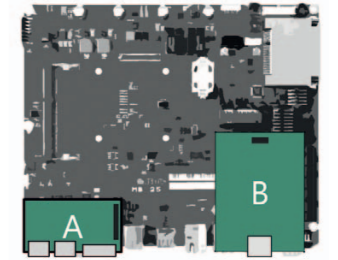

Technical data

	PB3200
PROCESSORS	Intel® Celeron 3765U 1,9Ghz, 2 cores - 2 threads - 2MB smart cache - 15W Intel® Core™ i3-5010U 2,1Ghz, 2 cores - 4 threads - 3MB smart cache - 15W Intel® Core™ i5-5350U 1,8Ghz (2,9Ghz Turbo), 2 cores - 4 threads - 3MB smart cache - 15W Intel® Core™ i7-5650U 2,2Ghz (3,1Ghz Turbo), 2 cores - 4 threads - 4MB smart cache - 15W
CHIPSET	Intel® Broadwell PCH-LP (Platform Controller Hub - Low Power) • Included into processor chip
VIDEO CONTROLLER	Intel® HD Graphics integrated in microprocessor Celeron 3765U, 850MHz Clock Intel® HD Graphics 5500 integrated in microprocessor i3, 900MHz Clock Intel® HD Graphics 6000 integrated in microprocessor i5, i7, 1GHz Clock with LVDS 8bit/colour digital interface
SYSTEM MEMORY - RAM	2GB or 4GB or 8GB or 16GB (1 x SODIMM DDR3 module)
MASS STORAGE	1 x bootable CFast SATA II slot onboard with external access 1 x onboard connector for direct insertion of mSATA SSD SATA III
SL/S0/S1	1 x bootable CFast SATA II slot onboard with external access 1 x onboard connector for 2.5" SSD/HDD SATA III with internal installation kit
S0/S1	1 x bootable CFast SATA II slot onboard with external access 1 x onboard connector for 2.5" SSD/HDD SATA III with internal installation kit
LAN	3 x Ethernet 10/100/1000 Mbps (RJ45 - 2 x Intel® I210-AT, 1 x Intel® I218-LM)
USB	2 x USB 3.0 (Type-A) 1 x USB 2.0 (Type-A)
SERIAL	1 x RS232 (DB9M)
VIDEO OUTPUT	1 x DVI-I
ADD-ON INTERFACES	1 x RS232/422/485 (DB15M)+ 1 x USB 2.0 (Type-A)
(only S0/S1)	1 x RS232/422/485 (DB15M) isolated + 1 x USB 2.0 (Type-A)
Position A	2 x RS232 (DB9M)
(max 1)	2 x USB 2.0 (Type-A)
Position B	1 x LAN 10/100/1000Mbps (RJ45 - Intel® I210)
(max 1)	1 x NETcore X fieldbus boards for EtherCAT, EtherNet IP, PROFINET, PROFIBUS, CANopen protocols 1 x Wi-Fi/Bluetooth/Modem adapter
EXPANSION SLOTS	S1 1 x PCI or 1 x PCIe x4
POWER SUPPLY INPUT	24VDC (18÷32VDC) isolated
POWER SUPPLY OPTIONS	UPS with external battery pack Kit for ATX mode power supply
O.S. CERTIFIED	Microsoft Windows 7 Pro/Ultimate 32/64 bit Microsoft Windows Embedded Standard 7E/7P 32/64 bit Microsoft Windows 10 IoT Enterprise 2016/2019 64 bit
OPERATING TEMPERATURE	0°C÷50°C 0°C÷45°C with 24x7 HDD
APPROVALS	CE, cULus LISTED (61010)

PB3500 [new]

Fanless Box IPCs based on Intel® Kaby Lake™ U platform



The fanless box IPC family PB3500 is based on the seventh generation Core i3, i5, i7 and Celeron of the Intel® Kaby Lake™ U platform. The "all in one" motherboard provides three Gigabit Ethernet ports, that support "Jumbo Frame" and "Wake on Lan" functionalities, four USB 3.0 ports, a serial RS232 interface,

a Display Port dual mode video output and a SATA III CFAST slot with external access, an M.2 connector for an NVMe/SATA III SSD, one SATA III connector for the installation of a 2.5" HDD/ SSD, up to 16 GB RAM with one DDR4 SODIMM module and two internal connectors for additional interfaces, DVI-D,

USB, Ethernet, Fieldbus and RVL for the remotation of the video and USB signals up to 100m (Remote Video Link). PB3500 systems have an isolated 24 VDC power supply input and optionally an integrated UPS with external battery pack. The systems are available in three versions, the SL with a

reduced depth, the S0 with the possibility to install additional interfaces and the S1 with a PCI or PCIe x4 slot.



+ Highlights

- UBIQUITY remote assistance software providing remote access to the system
- 15W seventh generation Core i3, i5, i7 and Celeron processors of the Intel® Kaby Lake™ U platform.
- "All in one" motherboard
- Fanless box IPC with 0°C÷50°C operating temperature
- Isolated 24 VDC power supply input
- Integrated UPS with external battery pack (optional)
- Onboard connector for NETcore X fieldbus boards
- SL version with reduced depth
- S1 version with one PCI or PCIe x4 expansion slot
- CE, cULus LISTED (61010) certifications

Gallery



Add-On boards

Position A

- 1 x RS232/422/485 + 1 x USB 2.0
- 1 x RS232/422/485 isol. + 1 x USB 2.0
- 1 x RS232 + 1 x USB 2.0
- 2 x RS232
- 2 x USB 2.0

Position B

- 1 x LAN Gigabit
- 1 x DVI-D
- 1 x RJ45 Remote Video Link (RVL OUT)
- 1 x NETcore X fieldbus board
- Wi-Fi/Bluetooth/Modem

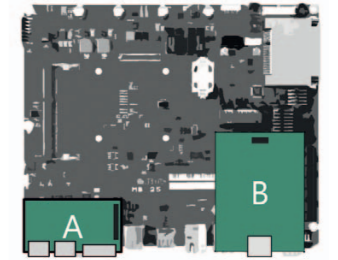

Technical data

		PB3500
PROCESSOR (soldered)		Intel® Celeron 3965U 2.20GHz 64bit, 2 cores / 2 threads, 2MB Smart cache Intel® Core i3-7100U 2.40GHz 64bit, 2 cores / 4 threads, 3MB Smart cache Intel® Core i5-7300U 2.60GHz (3.50GHz Turbo) 64bit, 2 cores / 4 threads, 3MB Smart cache Intel® Core i7-7600U 2.80GHz (3.90GHz Turbo) 64bit, 2 cores / 4 threads, 4MB Smart cache
CHIPSET		Intel® Broadwell PCH-LP (Platform Controller Hub - Low Power) • Included into processor chip
VIDEO CONTROLLER		Intel® HD Graphics 610 integrated in microprocessor Celeron 3965U • 300MHz/900MHz Intel® HD Graphics 620 integrated in Core i3 processors • 300MHz/1.00GHz Intel® HD Graphics 620 integrated in Core i5 processors • 300MHz/1.10GHz Intel® HD Graphics 620 integrated in Core i7 processor • 300MHz/1.15GHz DirectX 12 and OpenGL 4.5 support
SYSTEM MEMORY - RAM		4GB or 8GB or 16GB (1 x SODIMM DDR4 module)
MASS STORAGE	SL	1 x bootable CFAST SATA III slot onboard with external access 1 x onboard connector for direct insertion of M.2 2280 NVMe/SATA III SSD
	S0/S1	1 x bootable CFAST SATA III slot onboard with external access 1 x onboard connector for direct insertion of M.2 2280 NVMe/SATA III SSD 1 x onboard connector for 2.5" SSD/HDD SATA III with internal installation kit
LAN		3 x LAN 10/100/1000 Mbps (RJ45 - 2 x Intel® I210-AT, 1 x Intel® I219-LM)
USB		4 x USB 3.0 rear (Type-A)
SERIAL		1 x RS232 (DB9M)
VIDEO OUTPUT		1 x DP++
ADD-ON INTERFACES (only S0/S1)		1 x RS232/422/485 (DB15M) + 1 x USB 2.0 (Type-A) 1 x RS232/422/485 (DB15M) isolated + 1 x USB 2.0 (Type-A)
	Position A (max 1)	1 x RS232 (DB9M) + 1 x USB 2.0 (Type-A) 2 x RS232 (DB9M) 2 x USB 2.0 (Type-A)
	Position B (max 1)	1 x LAN 10/100/1000Mbps (RJ45 - Intel® I210) 1 x DVI-D 1 x RJ45 connector Remote Video Link (RVL OUT) 1 x NETcore X fieldbus boards for EtherCAT, EtherNet IP, PROFINET, PROFIBUS, CANopen protocols 1 x Wi-Fi/Bluetooth/Modem adapter
EXPANSION SLOTS	S1	1 x PCI or 1 x PCIe x4 (5 Gb/s)
POWER SUPPLY INPUT		24VDC (18÷32VDC) isolated
POWER SUPPLY OPTIONS		UPS with external battery pack Kit for ATX mode power supply
O.S. CERTIFIED		Microsoft Windows 10 IoT Enterprise 2016/2019 64bit
OPERATING TEMPERATURE		0° ÷ 50°C 0° - 45°C with 24x7 HDD
APPROVALS		CE, cULus LISTED (61010)

PB3400 / PB3600

Intel® Skylake™ H and Kaby Lake™ H based fanless box IPCs



The fanless Box IPC family PB3400 is based on the 6th generation Core i3, i5, i7 and Celeron processors of the Intel® Skylake™ H platform and the PB3600 family is based on the 7th generation Core i3, i5, i7 processors of the Intel® Kaby Lake™ H platform. The "all in one" motherboard provides four Ethernet 10/100/1000Mbps ports, that support "Jumbo Frame" and "Wake on Lan" functionalities,

three USB 3.0 ports, two USB 2.0 port, a serial RS232 interface, a DVI-D video output and a SATA III CFast slot with external access, an mSATA connector for a SATA III SSD, one SATA III connector for 2.5" SSDs/HDDs, up to 32 GB RAM with two DDR4 SODIMM modules and two internal connectors for additional interfaces, including RVL for the remotation of the video and USB signals up to 100m (Remote Video Link).

The systems have an isolated 24 VDC power supply input and optionally an integrated UPS with external battery pack. The systems are available in three versions, the S0 with the possibility to install additional interfaces, the S1 with a PCI or PCIe x4 slot and the D2 with two extractable 2.5" SSDs/HDDs.



+ Highlights

- UBIQUITY remote assistance software providing remote access to the system
- "All in one" motherboard
- High performance Intel® Skylake™ H (PB3400) and Kaby Lake™ H (PB3600) platforms
- Fanless box IPC with 0°C÷50°C operating temperature
- Isolated 24 VDC power supply input
- Onboard connectors for NETcore X fieldbus boards
- Integrated UPS with external battery pack (optional)
- S1 version with one PCI or PCIe x4 expansion slot
- CE, cULus LISTED (61010) certifications

Gallery



Add-On boards

Position A

- 1 x RS232/422/485 + 1 x USB 2.0
- 1 x RS232/422/485 isol. + 1 x USB 2.0
- 2 x RS232
- 2 x USB 2.0
- 1 x NETcore X fieldbus board

Position B

- 1 x LAN Gigabit
- 1/2 x RJ45 Remote Video Link (RVL OUT)
- 2 x Display Port dual mode
- 1 x NETcore X fieldbus board
- Wi-Fi/Bluetooth/Modem

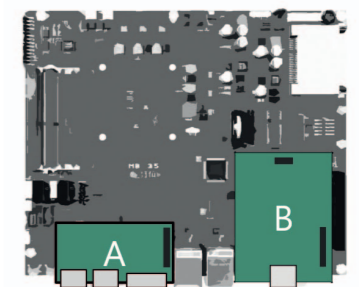

Technical data

		PB3400/PB3600
PROCESSORS (soldered)	PB3400	Intel® Celeron G3900E 2.40GHz 64bit, 2 cores / 2 threads, 2MB Smart cache Intel® Core i3-6100E 2.70GHz 64bit, 2 cores / 4 threads, 3MB Smart cache Intel® Core i5-6440EQ 2.70GHz (3.40GHz Turbo) 64bit, 4 cores / 4 threads, 6MB Smart cache Intel® Core i7-6820EQ 2.80GHz (3.50GHz Turbo) 64bit, 4 cores / 8 threads, 8MB Smart cache
	PB3600	Intel® Core i3-7100E 2.90GHz 64bit, 2 cores / 4 threads, 3MB Smart cache Intel® Core i5-7440EQ 2.90GHz (3.60GHz Turbo) 64bit, 4 cores / 4 threads, 6MB Smart cache Intel® Core i7-7820EQ 3.00GHz (3.70GHz Turbo) 64bit, 4 cores / 8 threads, 8MB Smart cache
	CHIPSET	PB3400 Intel® HM170 PCH (Platform Controller Hub) PB3600 Intel® HM175 PCH (Platform Controller Hub)
	VIDEO CONTROLLER	PB3400 Intel® HD Graphics 510 integrated in Celeron processor • 350MHz/950MHz • DirectX 12 and OpenGL 4.4 support Intel® HD Graphics 530 integrated in Core i3 processor • 350MHz/950MHz • DirectX 12 and OpenGL 4.4 support Intel® HD Graphics 530 integrated in Core i5, Core i7 processors • 350MHz/1,00GHz • DirectX 12 and OpenGL 4.4 support PB3600 Intel® HD Graphics 630 integrated in Core i3 processor • 350MHz/950MHz • DirectX 12 and OpenGL 4.5 support Intel® HD Graphics 630 integrated in Core i5, Core i7 processors • 350MHz/1,00GHz • DirectX 12 and OpenGL 4.5 support
SYSTEM MEMORY - RAM	4GB (1 x SODIMM DDR4 module) or 8GB or 16GB or 32GB (2 x SODIMM DDR4 modules)	
TPM	TPM module (optional)	
MASS STORAGE	1 bootable CFast SATA III slot onboard with external access 1 x onboard connector for direct insertion of mSATA SSD SATA III 1 x onboard connector for 2.5" SSD/HDD SATA III with internal installation kit	
OPTIONS	D2 Up to 2 extractable 2.5" SSD/HDD SATA III devices	
LAN	4 x LAN 10/100/1000Mbps (RJ45 - 3 x Intel® I210 + 1 x Intel® I219LM)	
USB	3 x USB 3.0, rear (Type-A) 2 x USB 2.0, rear (Type-A)	
SERIAL	1 x RS232 (DB9M)	
VIDEO OUTPUT	1 x DVI-D	
ADD-ON INTERFACES		1 x RS232/422/485 (DB15M)+ 1 x USB 2.0 (Type-A)
	Position A (max 1)	1 x RS232/422/485 (DB15M) isolated + 1 x USB 2.0 (Type-A) 2 x RS232 (DB9M) 2 x USB 2.0 (Type-A)
		1 x NETcore X fieldbus boards for EtherCAT, EtherNet IP, PROFINET, PROFIBUS, CANopen protocols
	Position B (max 1)	1 x connector Remote Video Link (RJ45 - RVL OUT) 2 x connectors Remote Video Link (RJ45 - RVL OUT) 1 x LAN 10/100/1000Mbps (Intel® I210) 1 x NETcore X fieldbus boards for EtherCAT, EtherNet IP, PROFINET, PROFIBUS, CANopen protocols
EXPANSION SLOTS	S1 1 x Wi-Fi/Bluetooth/Modem adapter 1 x PCI or 1 x PCIe x4 (5 Gb/s)	
POWER SUPPLY INPUT	24VDC (18÷32VDC) isolated	
POWER SUPPLY OPTIONS	UPS with external battery pack Kit for ATX mode power supply	
O.S. CERTIFIED	PB3400	Microsoft Windows 7 Pro/Ultimate 32/64bit Microsoft Windows Embedded Standard 7E/7P 32/64 bit Microsoft Windows 10 IoT Enterprise 2016/2019 64bit
	PB3600	Microsoft Windows 10 IoT Enterprise 2016/2019 64bit
OPERATING TEMPERATURE	0°C÷50°C	
APPROVALS	0°C÷45°C with 24x7 or Core i7 processors CE, cULus LISTED (61010)	

PB5400 / PB5600

Intel® Skylake™ S and Kaby Lake™ S based highly expandable box IPCs



The box IPC family PB5400 is based on the 6th generation Core i3, i5, i7 and Celeron processors of the Intel® Skylake™ S and the PB5600 family is based on the 7th generation Core i3, i5, i7 and Celeron processors of the Intel® Kaby Lake™ S platform. The "all in one" motherboard provides four Ethernet 10/100/1000Mbps ports, that support "Jumbo Frame" and "Wake on Lan" functionalities, four USB 3.0 ports, a serial

RS232 interface, a DVI-D video output, a SATA III CFast slot with external access, an M.2 2242/2280 SSD key M connector for a PCIe x4 SSD, two SATA III connectors for 2.5" SSDs/HDDs (optionally on extractable drawers), the possibility to set the mass storage drives in RAID 0, 1 configuration, up to 32 GB RAM with two DDR4 SODIMM modules and two internal connectors for additional interfaces, including RVL for

the remotation of the video and USB signals up to 100m (Remote Video Link). The systems have an isolated 24 VDC power supply input or, as an alternative, a 115/230 VAC power supply. The systems are available in three versions, the S0 with the possibility to install additional interfaces, the S1 with a x16 PCIe slot and the S3 with two x8 and a x4 PCIe slots or a x16, a x4 and a x1 PCIe slots.



+ Highlights

- UBIQUITY remote assistance software providing remote access to the system
- High performance Intel® Skylake™ S (HT/QT5400) and Kaby Lake™ S (HT/QT5600) platforms
- RAID 0,1 (optional, S3 version)
- "All in one" motherboard
- Box IPC with 0°C+50°C operating temperature
- 115/230 VAC or Isolated 24 VDC power supply input
- S1 version with one PCIe x16 expansion slot
- S3 version with one x16, one x4 and one x1 PCIe expansion slots or two x8 and one x4 PCIe expansion slots
- CE, cULus LISTED (61010) certifications

Gallery



Add-On boards

Position A

- 1 x RS232/422/485 + 1 x USB 2.0
- 1 x RS232/422/485 isol. + 1 x USB 2.0
- 2 x RS232
- 2 x USB 2.0
- 1 x NETcore X fieldbus board

Position B

- 1 x LAN Gigabit
- 1/2 x RJ45 Remote Video Link (RVL OUT)
- 2 x Display Port dual mode
- 1 x NETcore X fieldbus board
- Wi-Fi/Bluetooth/Modem

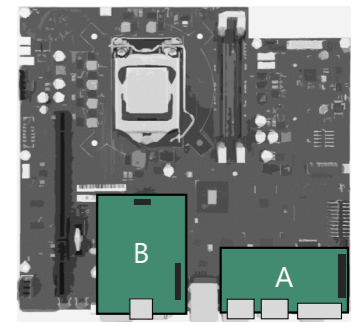

Technical data

		PB5400 / PB5600
PROCESSOR (soldered)	PB5400	Intel® Celeron G3900 2.8GHz, 2 cores, 2 Cores - 2 threads - 2MB smart cache Intel® Core™ i3-6100 3.7GHz, 2 Cores - 4 threads - 3MB smart cache Intel® Core™ i5-6500 3.2GHz (3.6GHz Turbo), 4 Cores - 4 threads - 6MB smart cache Intel® Core™ i7-6700 3.4GHz (4.0GHz Turbo), 4 Cores - 8 threads - 8MB smart cache
	PB5600	Intel® Celeron G3930TE 2.7GHz, 2 cores - 2 threads - 2MB smart cache Intel® Core™ i3-7101E 3.9GHz, 2 Cores - 4 threads - 3MB smart cache Intel® Core™ i5-7500 3.4GHz (3.8GHz Turbo), 4 Cores - 4 threads - 6MB smart cache Intel® Core™ i7-7700 3.6GHz (4.2GHz Turbo), 4 Cores - 8 threads - 8MB smart cache
	CHIPSET	Intel® C236 PCH (Platform Controller Hub)
	VIDEO CONTROLLER	Intel® HD Graphics 510 integrated in Celeron G3900, 350/950MHz Clock Intel® HD Graphics 530 integrated in i3-6100 / i5-6500, 350/1.05GHz Clock Intel® HD Graphics 530 integrated in i7-6700, 350MHz/1.15GHz Clock
	PB5600	Intel® HD Graphics 610 integrated in Celeron G3930TE, 350/950MHz Clock Intel® HD Graphics 630 integrated in i3-7101E / i5-7500, 350/1.10GHz Clock Intel® HD Graphics 630 integrated in i7-7700 350/1.15GHz Clock
SYSTEM MEMORY - RAM		4GB (1 x SODIMM DDR4 module) /8GB/16GB/32GB (2 x SODIMM DDR4 modules)
TPM		TPM module (optional)
MASS STORAGE		1 x bootable CFast SATA III slot on board with external access 1 x onboard connector for direct insertion of M.2 2242/2280 SSD key M PCIe4 2 x onboard connector for 2,5" SSD/HDD SATA III
OPTIONS	S0	1 x extractable drawer for 2.5" units
	S1/S3	2 x extractable drawers for 2.5" units
RAID CONTROLLER		Integrated into chipset Intel® C236
LAN		4 x LAN 10/100/1000Mbps (RJ45 - 3 x Intel® I210 + 1 x Intel® I219LM)
USB		3 x USB 3.0, rear (Type-A) 2 x USB 2.0, rear (Type-A)
SERIAL		1 x RS232 (DB9M)
VIDEO OUTPUT		1 x DVI-D
ADD-ON INTERFACES (max 1)		1 x RS232/422/485 (DB15M)+ 1 x USB 2.0 (Type-A)
		1 x RS232/422/485 (DB15M) isolated + 1 x USB 2.0 (Type-A)
	Position A	2 x RS232 (DB9M) 2 x USB 2.0 (Type-A)
		1 x LAN 10/100/1000Mbps (RJ45 - Intel® I210) + 1 x USB 2.0 (Type-A)
	Position B	1 x LAN 10/100/1000Mbps (RJ45 - Intel® I210) 1 x RJ45 connector Remote Video Link (RVL OUT) 2 x RJ45 connectors Remote Video Link (RVL OUT) 2 x DP++ Video output (no audio) 1 x NETcore X fieldbus boards for EtherCAT, EtherNet IP, PROFINET, PROFIBUS, CANopen protocols 1 x Wi-Fi/Bluetooth/Modem adapter
EXPANSION SLOTS	S1	1 x PCIe x16
	S3	1x PCIe x16 + 1x PCIe x4 + 1x PCIe x1 2 x PCIe x8 + 1 x PCIe x4
POWER SUPPLY INPUT		24VDC (18÷32VDC) isolated 115/230VAC
POWER SUPPLY OPTIONS		Kit for ATX mode power supply (optional)
O.S. CERTIFIED	PB5400	Microsoft Windows 10 IoT Enterprise 2019 64bit • Microsoft Windows 10 IoT Enterprise 2016 64bit • Windows 7 Pro/Ultimate 32/64bit • Windows Embedded Standard 7E/7P 32/64 bit • Microsoft Windows Server 2016/2019 Standard
	PB5600	Microsoft Windows 10 IoT Enterprise 2019 64bit • Microsoft Windows 10 IoT Enterprise 2016 64bit • Microsoft Windows Server 2016/2019 Standard
OPERATING TEMPERATURE		0°C÷50°C 0°C÷45°C with 24x7 HDD
APPROVALS		CE, cULus LISTED (61010)

Arm Mounting IPCs

The Arm Mounting IPCs are compact, fanless, ergonomic and easy to install systems with a stylish design, that are easy to install and compatible with the most common mounting standards.



VK3200

Intel® Broadwell™ U fanless arm mounting IPCs



The fanless Arm Mounting IPC family VK3200 is based on the fifth generation Core i3, i5, i7 and Celeron of the Intel® Broadwell™ U platform. They are made of a Full IP65 cast aluminium chassis, powder coated with anti-scratch treatment compatible with the most used installation standards. The front button area is available in Hard-Wired or Fieldbus (EtherCAT Slave) versions and it is totally configurable.

It allows to install light indicators, buttons, lever switches, keylock switches, encoders, an emergency stop button and USB, Ethernet or RFID interfaces (described in the "Configurations and Options" section). The "all in one" motherboard provides two USB 3.0 ports with rear external protected access and, inside the chassis, three Ethernet 10/100/1000Mbps ports, that support "Jumbo Frame" and

"Wake on Lan" functionalities, two USB 2.0 port, a SATA III CFast slot, an mSATA connector for SATA III SSD and up to 8 GB RAM with one DDR3 SODIMM module. The VK3200 family is available with 16 million colours LED Backlight TFT LCDs from 15.6" to 24", in Wide aspect ratio, with aluminium True flat front panels and 5 wires resistive touchscreen or with aluminium and glass TrueFlat Multitouch front panels

and projected capacitive touchscreen. VK3200 systems have an isolated 24 VDC power supply input.



+ Highlights

- UBIQUITY remote assistance software providing remote access to the system
- Full IP65 chassis
- Button area with up to 15 Ø22 elements, Hard-Wired or Fieldbus versions (EtherCAT Slave)
- "All in one" motherboard
- Intel® Broadwell™ U platform
- Fanless arm mounting IPC with 0°C+50°C operating temperature
- 15.6", 18.5", 21.5" and 24" LCDs in Wide aspect ratio
- Isolated 24 VDC power supply input
- CE, ULus LISTED (61010) certifications

Gallery

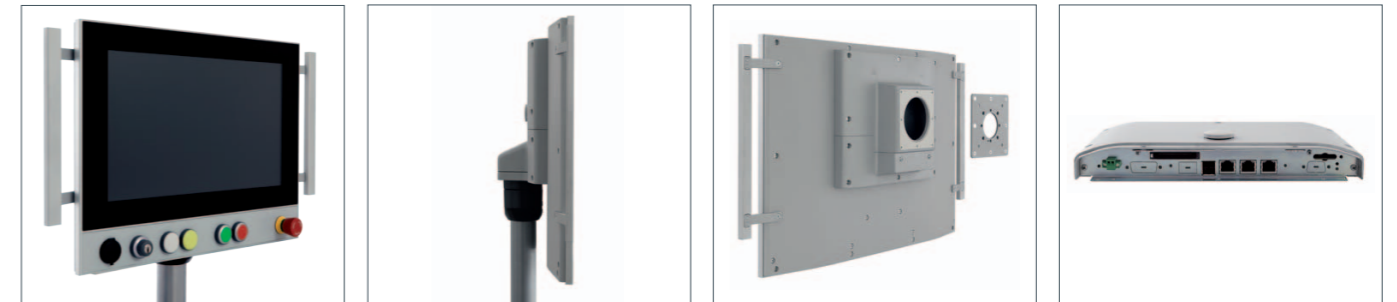

Technical data

	VK3200-TF	VK3200-TFM
LED backlight TFT LCD	15.6" W - 1366x768 15.6" W - 1920x1080 18.5" W - 1366x768 18.5" W - 1920x1080 21.5" W - 1920x1080	15.6" W - 1366x768 15.6" W - 1920x1080 18.5" W - 1366x768 18.5" W - 1920x1080 21.5" W - 1920x1080 24" W - 1920x1080
TOUCHSCREEN	Resistive 5 wires	P-CAP Multitouch
FRONT PANEL	True Flat Aluminum	
PROTECTION GRADE	Full IP65	
PROCESSOR	Intel® Celeron 3765U 1,9Ghz, 2 cores - 2 threads - 2MB smart cache - 15W Intel® Core™ i3-5010U 2,1Ghz, 2 cores - 4 threads - 3MB smart cache - 15W Intel® Core™ i5-5350U 1,8Ghz (2,9GHz Turbo), 2 cores - 4 threads - 3MB smart cache - 15W Intel® Core™ i7-5650U 2,2Ghz (3,1GHz Turbo), 2 cores - 4 threads - 4MB smart cache - 15W	
CHIPSET	Intel® Broadwell PCH-LP (Platform Controller Hub - Low Power) • Included into processor chip	
VIDEO CONTROLLER	Intel® HD Graphics integrated in microprocessor Celeron 3765U, 850MHz Clock Intel® HD Graphics 5500 integrated in microprocessor i3, 900MHz Clock Intel® HD Graphics 6000 integrated in microprocessor i5, i7, 1GHz Clock with LVDS 8bit/color digital interface	
SYSTEM MEMORY - RAM	2GB or 4GB or 8GB or 16GB (1 x SODIMM DDR3 module)	
MASS STORAGE	1 bootable CFast SATA III slot onboard with internal access 1 x onboard connector for direct insertion of mSATA SSD SATA III	
LAN	3 x LAN 10/100/1000Mbps (2 x Intel® I210-AT, 1 x Intel® I218-LM)	
USB	2 x USB 3.0, external, rear, protected, IP65 (Type-A) 2 x USB 2.0, internal (Type-A)	
ADD-ON INTERFACES	1 x RS232/422/485 (DB15M)	
Position A (max 1)	1 x RS232/422/485 (DB15M) isolated	
Position B (max 1)	1 x NETcore X fieldbus boards for EtherNet IP, PROFINET, PROFIBUS, CANopen protocols 1 x Wi-Fi/Bluetooth adapter	
CASE	For VESA 75/100 or for pole / suspension arm mounting system compatible with RITTAL CP40/ROLEC TARAPLUS/ HASEKE ULT KÜPPLUNG 48	
Installation	Aluminium alloy EN AB46400	
Material	Anti-scratchable painted - RAL 9006	
Colour	Side handles, perimetral handle, keyboard holder kit	
Accessories	See "Configurations & Options" section at the end of this brochure	
BUTTONS AREA (optional)		
POWER SUPPLY INPUT	24VDC (18+32VDC) isolated Kit for ATX mode power supply (optional, on button area)	
O.S. CERTIFIED	Microsoft Windows 7 Pro/Ultimate 32/64bit Microsoft Windows Embedded Standard 7E/7P 32/64 bit Microsoft Windows 10 IoT Enterprise 2016/2019 64 bit	
OPERATING TEMPERATURE	0°C+50°C	
APPROVALS	CE, ULus (61010)	

VK3500 [new]

Arm Mounting fanless IPC based on Intel® Kaby Lake™ U platform



The fanless Arm Mounting IPC family VK3500 is based on the seventh generation Core™ i3, i5, i7 and Celeron® processors of the Intel® Kaby Lake™ U at 15W platform. VK3500 is made of a Full IP65 cast aluminium chassis, powder coated with anti-scratch treatment compatible with the most used installation standards. The front button area is available in Hard-

Wired version and it is totally configurable. It allows to install light indicators, buttons, lever switches, keylock switches, encoders, an emergency stop button and USB, Ethernet or RFID interfaces (described in the "Configurations and Options" section). The "all in one" motherboard provides three Gigabit Ethernet ports, that support "Jumbo Frame" and "Wake on Lan"

functionalities, two USB 3.0 port, a SATA III CFast slot, an M.2 connector for NVMe/SATA III SSD, up to 16 GB RAM with one DDR4 SODIMM module and two internal connectors for additional interfaces. The VK3500 family is available with the new minimized frame in aluminium and glass TrueFlat Multitouch, projected capacitive touchscreen, with 16 million colours LED Backlight TFT LCDs

from 15.6" to 24", in Wide aspect ratio. VK3500 systems have an isolated 24 VDC power supply input.



+ Highlights

- UBIQUITY remote assistance software providing remote access to the system
- Arm Mounting fanless IPC with 0°C÷50°C operating temperature
- Full IP65 chassis
- Button area with up to 15 Ø22 elements, Hard-Wired
- "All in one" motherboard
- Intel® Kaby Lake™ U platform
- 15.6", 18.5", 21.5" and 24" LCDs in Wide aspect ratio
- Isolated 24 VDC power supply input
- CE, ULus LISTED (61010) certifications

Gallery



Technical data

		VK3500-TFM
LED backlight TFT LCD		15.6" W - 1366x768 15.6" W - 1920x1080 18.5" W - 1366x768 18.5" W - 1920x1080 21.5" W - 1920x1080 24" W - 1920x1080"
TOUCHSCREEN		P-CAP multitouch
FRONT PANEL		True Flat Aluminium
PROTECTION GRADE		Full IP65
PROCESSOR		Intel® Celeron 3965U 2.20GHz 64bit, 2 cores / 2 threads, 2MB Smart cache Intel® Core i3-7100U 2.40GHz 64bit, 2 cores / 4 threads, 3MB Smart cache Intel® Core i5-7300U 2.60GHz (3.50GHz Turbo) 64bit, 2 cores / 4 threads, 3MB Smart cache Intel® Core i7-7600U 2.80GHz (3.90GHz Turbo) 64bit, 2 cores / 4 threads, 4MB Smart cache
CHIPSET		Intel® Kaby Lake PCH-LP (Platform Controller Hub - Low Power) • Included into processor chip
VIDEO CONTROLLER		Intel® HD Graphics 610 integrated in microprocessor Celeron 3965U • 300MHz/900MHz Intel® HD Graphics 620 integrated in Core i3 processors • 300MHz/1.00GHz Intel® HD Graphics 620 integrated in Core i5 processors • 300MHz/1.10GHz Intel® HD Graphics 620 integrated in Core i7 processor • 300MHz/1.15GHz DirectX 12 and OpenGL 4.5 support"
SYSTEM MEMORY - RAM		4GB or 8GB or 16GB (1 x SODIMM DDR4 module)
MASS STORAGE		1 x bootable CFast SATA III slot onboard with external access 1 x onboard connector for direct insertion of M.2 2280 NVMe PCIe x2
LAN		3 x LAN 10/100/1000 Mbps (RJ45 - 2 x Intel® I210-AT, 1 x Intel® I219-LM)
USB		3 x USB 2.0 rear (Type-A)
ADD-ON INTERFACES		1 x RS232/422/485 (DB15M)
	Position A (max 1)	1 x RS232/422/485 (DB15M) isolated 1 x LAN 10/100/1000 Mbps (RJ45 - Intel® I210) 2 x USB 3.0 (Type-A)
	Position B (max 1)	1 x NETcore X fieldbus boards for EtherNet IP, PROFINET, PROFIBUS, CANopen protocols 1 x Wireless/Bluetooth adapter
CASE	Installation	For VESA 75/100 or for pole/suspension arm mounting system compatible with RITTAL CP40/ROLEC TARAPLUS/HASEKE ULT KUPPLUNG 48
	Material	Aluminium alloy AN AB46400
	Colour	Anti-scratchable painted - RAL 9006
	Accessories	Side handles, perimetral handle, keyboard holder kit
BUTTONS AREA (optional)		See "Configurations & Options" section at the end of the brochure
POWER SUPPLY INPUT		24VDC (18÷32VDC) isolated
POWER SUPPLY OPTIONS		Kit for ATX mode power supply
O.S. CERTIFIED		Microsoft Windows 10 IoT Enterprise 2016/2019 64bit
OPERATING TEMPERATURE		0°C÷50°C
APPROVALS		CE, ULus LISTED (61010)

VPC2200

Intel® Bay Trail™ fanless arm mounting IPCs



The fanless Arm Mounting IPC family VPC2200 is based on the Celeron J1900 2GHz quad core 64 bit processor of the Intel® Bay Trail™ System On Chip (SoC) platform. They are made of a Full IP65 cast aluminium chassis, powder coated with anti-scratch treatment and it is compatible with VESA, Roolec Taraplus and Rittal CP-40 standards. A keyboard and two side modules

are available, both with predisposition to install light indicators, buttons, lever switches, keylock switches and an emergency stop button. The "all in one" motherboard provides, inside the chassis, two Ethernet 10/100/1000Mbps ports, that support "Jumbo Frame" and "Wake on Lan" functionalities, one USB 3.0 port, two USB 2.0 ports, a serial RS232 interface, a DVI-I (DVI-D + VGA) video

output, a SATA II CFAST slot, an mSATA connector for SATA II SSD and up to 8 GB RAM with one DDR3 SODIMM module. The VPC2200 family is available with 16 million colours LED Backlight TFT 15" LCD in 4:3 aspect ratio, with aluminium front panel, 5 wires resistive touchscreen and two additional USB 2.0 ports on front. VPC2200 systems have an isolated 24 VDC power supply

input and the VPC2200-E version integrates a MiniPCI slot for the installation of ASEM NETcore® X fieldbus boards.



+ Highlights

- UBIQUITY remote assistance software providing remote access to the system
- Pole or Arm Mounting system, compatible with VESA 75-100, RITTAL CP40, ROLEC TARAPLUS
- Two side button areas for Ø22 elements (optional)
- Keyboard module (optional)
- "All in one" motherboard
- High performance Intel® Bay Trail™ SoC platform
- Fanless arm mounting IPC with 0-45° C operating temperature
- 15" LCD in 4:3 aspect ratio
- Isolated 24 VDC power supply input
- CE certification

Gallery



Technical data

	VPC2200	VPC2200-E
LED backlight TFT LCD	15.0" - 1024x768	
TOUCHSCREEN	Resistive 5 wires	
FRONT PANEL	Aluminium alloy with polycarbonate foil Pantone 429C colour	
PROTECTION GRADE	IP65 frontal	
PROCESSOR	Intel® Celeron J1900 2.0Ghz, 4 cores / 4 threads, 2MB L2 cache, soldered	
VIDEO CONTROLLER	Intel® HD Graphics integrated in microprocessor, 688MHz Clock 854MHz Turbo, LVDS 8bit/colour digital interface	
SYSTEM MEMORY - RAM	1GB or 2GB or 4GB or 8GB (1 x SODIMM DDR3 module)	
MASS STORAGE	1 x SSD mSATA/2.5" SATA II	1 x SSD mSATA/2.5" SATA II
	1 bootable CFAST SATA II slot onboard, internal access	
LAN	2 x LAN 10/100/1000Mbps (2 x Intel® I210)	2 x LAN 10/100/1000Mbps (2 x Intel® I210)
	1 x LAN 10/100/1000Mbps (1 x Intel® I210) (optional)	
USB	2 x USB 2.0 external front, protected (Type-A) 1 x USB 3.0 internal (Type-A) 2 x USB 2.0 internal (Type-A)	
SERIAL	1 x RS232 (DB9M)	
EXPANSION SLOTS	-	1 x MiniPCI dedicated to ASEM fieldbuses boards
VIDEO OUTPUT	1 x DVI-I (DVI-D + VGA with adapter)	
CASE	Installation	For pole or suspension arm mounting system compatible with VESA 75/100 RITTAL CP40 ROLEC TARAPLUS
	Material Colour	Steel Anti-scratchable painted RAL 7035
BUTTONS & LEADS (optional)	Side modules for emergency stop button, buttons, lights, keys and switches	
KEYBOARD (optional)	US-international layout keyboard module with 86 keys and antiglare protection also with emergency button	
POWER SUPPLY INPUT	24VDC (18+32VDC) isolated	
O.S. CERTIFIED	Microsoft Windows 7 Pro/Ultimate 32/64bit Microsoft Windows Embedded Standard 7E/7P 32/64 bit Microsoft Windows 8.1 Industry Pro 32/64bit Microsoft Windows 10 IoT Enterprise 2016/2019 64 bit	
OPERATING TEMPERATURE	0°C÷45°C	
APPROVALS	CE	

Rack IPCs

19" 4U rack solutions with a wide range of configurations, motherboards, expansion slots and Intel® Xeon™ and Core™ i3, i5, i7 dual, quad and exa core processors up to Intel® Coffee Lake™ platform.



PR4048 / PR4148

Intel® Skylake™ based rack IPCs



The 19" Rack IPC PR4048/4148 family is based on the sixth generation Core™ i3, i5, i7 and Xeon processors of the Intel® Skylake™ platform.

The motherboard includes two Ethernet 10/100/1000Mbps ports that support "Jumbo Frame" and "Wake on Lan" functionalities, four USB 3.0 ports, four USB 2.0 ports, one

RS232 serial interface, two DisplayPort and a DVI-D video outputs; on the front, two USB 3.0 ports. The motherboard also has an mSATA connector for a SATA III SSD, six SATA III connectors for 2.5" or 3.5" units (also on extractable drawers), the possibility to set the mass storage drives in RAID 0, 1, 5, 10 configuration and up to 64 GB RAM with

four DDR4 DIMM modules. PR4048/4148 systems are provided with 110/230 VAC power supply and are available in two versions, PR4048 with up to two 500W redundant power supplies and PR4148, with reduced depth chassis.

+ Highlights

- "Heavy-duty" motherboard for 24/7 industrial applications
- Extractable drawers for 2.5" or 3.5" mass storages
- Intel® Skylake™ dual and quad core platform
- Rack IPC with 0-40° operating temperature
- 110/230 VAC power supply input
- PR4148 version with compact cabinet

PR4049 / PR4149

Intel® Kaby Lake™ based rack IPCs



The 19" Rack IPC PR4049/4149 family is based on the seventh generation Core™ i3, i5, i7 and Xeon™ processors of the Intel® Kaby Lake™ platform.

The motherboard includes two Ethernet 10/100/1000Mbps ports that support "Jumbo Frame" and "Wake on Lan" functionalities, four USB 3.0 ports, four USB 2.0 ports, one

RS232 serial interface, two DisplayPort and a DVI-D video outputs; on the front, two USB 3.0 ports. The motherboard also has an mSATA connector for a SATA III SSD, six SATA III connectors for 2.5" or 3.5" units (also on extractable drawers), the possibility to set the mass storage drives in RAID 0, 1, 5, 10 configuration and up to 64 GB RAM with

four DDR4 DIMM modules. PR4049/4149 systems are provided with 110/230 VAC power supply and are available in two versions, PR4049 with up to two 500W redundant power supplies and PR4149, with reduced depth chassis.

+ Highlights

- "Heavy-duty" motherboard for 24/7 industrial applications
- Extractable drawers for 2.5" or 3.5" mass storages
- Intel® Kaby Lake™ dual and quad core platform
- Rack IPC with 0-40° operating temperature
- 110/230 VAC power supply input
- PR4149 version with compact cabinet

PR4050 / PR4150

Intel® Coffee Lake™ based rack IPCs



The 19" rack IPC PR4050/4150 family is based on the eighth generation Core™ i3, i5, i7 and Xeon™ processors of the Intel® Coffee Lake™ platform. The motherboard includes two Ethernet 10/100/1000Mbps ports that support "Jumbo Frame" and "Wake on Lan" functionalities, four USB 3.0 ports, four USB 2.0 ports, one RS232 serial interface, two

DisplayPort and a DVI-D video outputs; on the front, two USB 3.0 ports. The motherboard also has an M.2 2280 connector for a SATA III/PCIe x4 SSD, six SATA III connectors for 2.5" or 3.5" units (also on extractable drawers), the possibility to set the mass storage drives in RAID 0, 1, 5, 10 configuration and up to 64 GB RAM with four DDR4

DIMM modules. PR4050/4150 systems are provided with 110/230 VAC power supply and are available in two versions, PR4050 with up to two 500W redundant power supplies and PR4150, with reduced depth chassis.

+ Highlights

- "Heavy-duty" motherboard for 24/7 industrial applications
- Extractable drawers for 2.5" or 3.5" mass storages
- Intel® Coffee Lake™ dual, quad and exa core platform
- Rack IPC with 0-40° operating temperature
- 110/230 VAC power supply input
- PR4150 version with compact cabinet

Technical Data

	PR4048	PR4148	PR4049	PR4149	PR4050	PR4150
19" RACK CABINET	long	short	long	short	long	short
MOTHERBOARD	ATX format, D3446-S2 (Fujitsu)				ATX format, D3446-S (Fujitsu)	
PROCESSOR	Intel® Core™ i3-6100, 3,7 GHz, 2 cores / 4 threads, 3MB L2, 14nm technology	Intel® Core™ i5-6400 2.7GHz (3.3GHz Turbo), 4 cores / 4 threads, 3MB L2, 14nm technology	Intel® Core™ i3-7100, 3,9GHz, 2 cores / 4 threads, 3MB L2, 14nm technology	Intel® Core™ i5-7500, 3,4GHz (3,8GHz Turbo), 4 cores / 4 threads, 6MB L2, 14nm technology	Intel® Core™ i3-8100 • 3,6 GHz • 4 cores • 4 threads • 6MB cache • 64bit • 14nm technology	Intel® Core™ i5-8500 • 3,0 GHz (4,1 GHz Turbo) • 6 cores • 6 threads • 9MB cache • 64bit • 14nm technology
	Intel® Core™ i5-6600, 3,3 GHz (3,9 GHz Turbo), 4 cores / 4 threads, 6MB L2, 14nm technology	Intel® Core™ i7-6700, 3,4 GHz (4,0 GHz Turbo), 4 cores / 8 threads, 8MB L2, 14nm technology	Intel® Core™ i5-7600, 3,5GHz (4,1GHz Turbo), 4 cores / 4 threads, 6MB L2, 14nm technology	Intel® Core™ i7-7700, 3,6GHz (4,2GHz Turbo), 4 cores / 8 threads, 8MB L2, 14nm technology	Intel® Core™ i7-8700 • 3,2 GHz (4,6 GHz Turbo) • 6 cores • 12 threads • 12MB cache • 64bit • 14nm technology	Intel® Xeon™ E-2124G • 3,4 GHz (4,5 GHz Turbo) • 4 cores • 4 threads • 8MB cache • 64bit • 14nm technology
	Intel® Xeon™ E3-1225 V5, 3,3 GHz (3,7 GHz Turbo), 4 cores / 4 threads, 8MB L2, 14nm technology	Intel® Xeon™ E3-1275 V5, 3,6 GHz (4,0 GHz Turbo), 4 cores / 8 threads, 8MB L2, 14nm technology	Intel® Xeon™ E3-1225 V6, 3,3GHz (3,7GHz Turbo), 4 cores / 4 threads, 8MB L2, 14nm technology	Intel® Xeon™ E3-1275 V6, 3,8GHz (4,2GHz Turbo), 4 cores / 8 threads, 8MB L2, 14nm technology	Intel® Xeon™ E-2176G • 3,7 GHz (4,7 GHz Turbo) • 6 cores • 12 threads • 12MB cache • 64bit • 14nm • Socket LGA1151	
CHIPSET	Intel® C236 Express Chipset				Intel® C246 Express Chipset	
O.S. CERTIFIED	Microsoft Windows 10 IoT Enterprise 64 bit, Microsoft Windows 8.1 Industry Pro 32/64 bit, Microsoft Windows 7 32/64 bit, Microsoft Windows Server 2012 R2 64 bit Standard Edition			Microsoft Windows 10 IoT Enterprise 64 bit, Microsoft Windows Server 2016 Standard, Microsoft Windows Server 2019 Standard		
VIDEO CONTROLLER	Intel® HD Graphics 530 integrated in Core i3-6100 processors, 350MHz/1,05GHz	Intel® HD Graphics 530 integrated in Core i5-6600, Core i7-6700 processors, 350MHz/1,15GHz	Intel® HD Graphics 630 integrated in Core i3-7100, i5-7500 processors, 350MHz/1,10GHz	Intel® HD Graphics 630 integrated in Core i5-7600, Core i7-7700 and Xeon processors, 350MHz/1,15GHz	Intel® UHD Graphics 630 integrato nei processori Core i3 e i5 • 350MHz/1,10GHz	Intel® UHD Graphics 630 integrato nel processore Core i7 • 350MHz/1,2GHz
	Intel® HD Graphics P530 integrated in Xeon processors, 400MHz/1,15GHz DirectX 12 and OpenGL 4.4 support				Intel® UHD Graphics P630 integrato nel processore Xeon™ E-2124G • 350MHz/1,15GHz	Intel® UHD Graphics P630 integrato nel processore Xeon™ E-2176G • 350MHz/1,2 GHz
VIDEO LIBRARY SUPPORT	DirectX 12 and OpenGL 4.4 support		DirectX 12 and OpenGL 4.5 support			
SYSTEM MEMORY	4GB / 8GB / 16GB / 32GB / 64GB DDR4					
EXPANSION SLOTS	2 x PCI full size (32 bit, 33MHz, Rev.2.3) 2 x PCIe x16 (16 lanes, Gen3, 4 lanes, Gen3) 1 x PCIe x8 (1 lane, Gen3) 2 x PCIe x4 (4 lanes, Gen3, 1 lane, Gen3)			2 x PCI full size (32 bit, 33MHz, Rev.2.3) 1 x PCIe x16 (16 lanes, Gen3) 1 x PCIe x16 (4 lanes, Gen3) 2 x PCIe x8 (1 lane, Gen3) 1 x PCIe x1 (1 lanes, Gen3)		
DRIVE BAY	3 x 5,25" external 1 x 3,5" external + 2 x 3,5" internal	3 x 5,25" external 1 x 3,5" external + 3 x 3,5" internal	3 x 5,25" external 1 x 3,5" external + 2 x 3,5" internal	3 x 5,25" external 1 x 3,5" external + 3 x 3,5" internal	3 x 5,25" external 1 x 3,5" external + 2 x 3,5" internal	3 x 5,25" external 1 x 3,5" external + 3 x 3,5" internal
SPECIAL FEATURES	24/7 operation					
DRIVE INTERFACES	1 x mSATA III 6Gbit/s - 6 x SATA III 6Gbit/s				1 x M.2 2280 PCIe x4 - 6 x SATA III 6Gbit/s	
MASS STORAGE	up to 4 x HDDs 3,5" SATA III without or with extractable drawer in a 5,25" bay (max 3) up to 4 x SSDs 2,5" SATA III without or with extractable drawer in a 3,5" bay (max 2)					
RAID	RAID 0, 1, 5, 10 on SATA III					
OPTICAL DRIVE	1 x DVD-RW					
LAN	2 x LAN 10/100/1000Mbps (1 x Intel® I210AT, 1 x Intel® I219LM)					
USB	4 x USB 3.0 rear (Type-A) - 4 x USB 2.0 rear (Type-A) - 2 x USB 3.0 front (Type-A)					
SERIAL	1 x DVD-RW					
KEYBOARD & MOUSE	2 x PS/2 (K/M)					
VIDEO OUTPUT	1 x DVI-D 2 x DisplayPort					
AUDIO	Realtek ALC671, 5.1-channel, High Definition Audio Codec, S/PDIF					
ADDITIONAL INTERFACES	2 x RS232 (DB9M) 2 x USB 2.0 for internal dongle				up to 3x RS232 (DB9M) 1 x USB 2.0 + 1 x USB 3.0 for internal dongle	
POWER SUPPLY INPUT	230VAC 400/650W 230VAC 2 x 500W	230VAC 400/650W	230VAC 400/650W 230VAC 2 x 500W	230VAC 400/650W	230VAC 400/650W 230VAC 2 x 500W	230VAC 400/650W
DIMENSIONS w-h-d	48.3 x 17.8 x 50.3 cm	48.3 x 17.8 x 46.5 cm	48.3 x 17.8 x 50.3 cm	48.3 x 17.8 x 46.5 cm	48.3 x 17.8 x 50.3 cm	48.3 x 17.8 x 46.5 cm
OPERATING TEMPERATURE	0° - 40°C with 24x7 HDD 5° - 40°C with standard HDD					
APPROVALS	CE					

Industrial Monitors

The panel Industrial Monitors are available with LCDs from 8.4" to 24", with 4:3, 5:4 or Wide format, and six front panels, with IP66 protection grade.

Arm Mounting Monitors are compact, fanless, ergonomic and easy to install solutions, compatible with the most common mounting standards and are available with 15.6", 18.5", 21.5" and 24" TFT LCDs in a full IP65 aluminium chassis.

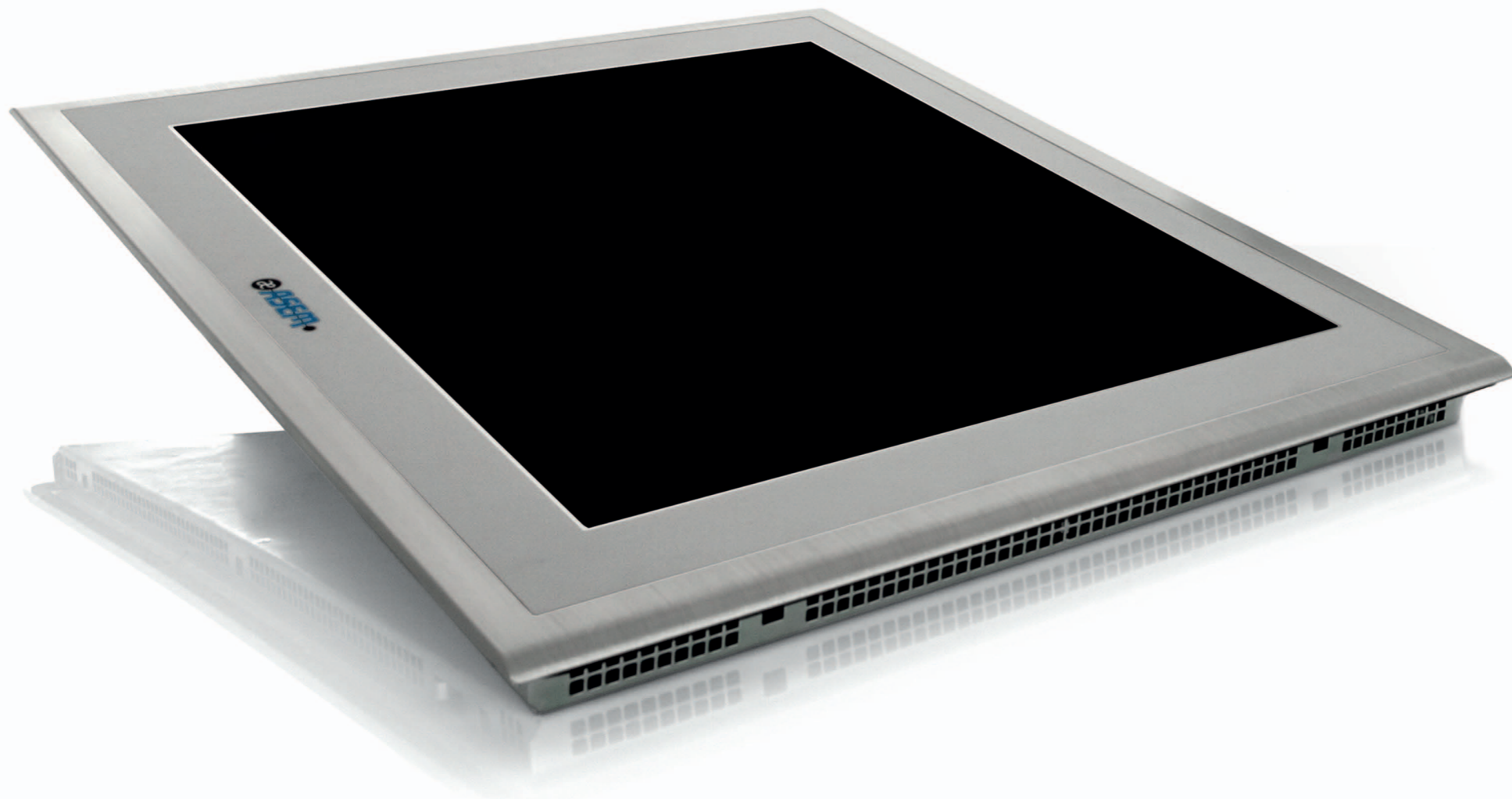

MH/MHR100 / MQ/MQR100

Panel Mounting industrial monitors



The panel monitor family MQ100/MQR100 is available with the new front panels with minimized frame, 16 million colours LED Backlight TFT LCDs from 10.1" to 24", in 4:3 and Wide aspect ratio, with aluminium front panel and a 5 wires resistive touchscreen, or aluminium and glass TrueFlat Multitouch front panels, with projected capacitive touchscreen. Alternatively, the family MH100/MHR100 is available with 16 million colours LED

Backlight TFT LCDs from 8.4" to 24", in 4:3, 5:4 and Wide aspect ratio, with aluminium or aluminium True flat front panels, 5 wires resistive touchscreen and an additional USB 2.0 port on front. As an alternative, the systems with 12.1", 15", 17" and 19" LCD can have a Stainless Steel True Flat front panel. All version with Wide LCDs are also available with aluminium and glass TrueFlat Multitouch front panels, with projected capacitive touchscreen.

MH100 and MQ100 versions have a VGA and a DVI-D standard input, while MHR100 and MQR100 versions integrate the remotation technology for DVI and USB 2.0 signals that allows the connection of the IPC within 100 meters with a Cat 5e SF/UTP or CAT6A S/FTP cable.



+ Highlights

- Industrial Monitor with 0°C÷50°C operating temperature
- 8.4", 10.4", 12.1" and 15" LCDs in 4:3 aspect ratio, 17" and 19" LCDs in 5:4 aspect ratio, 10.1", 12.1", 15.6", 18.5", 21.5" and 24" LCDs in Wide aspect ratio
- Isolated 24 VDC power supply input or 110/230 VAC power supply (optional)
- MHR100 and MQR100 version with remotation of DVI and USB 2.0 signals up to 100m
- CE, cULus LISTED certifications

Gallery



Remotation

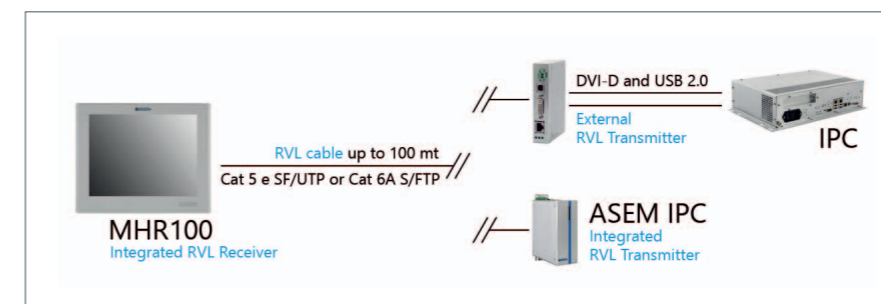

Technical data

	MQ100 MQR100	MQ100-TFM MQR100-TFM	MH100 MHR100	MH100-TF MHR100-TF	MH100-TFX MHR100-TFX	MH100-TFM MHR100-TFM	
LED backlight TFT LCD	10.1" W - 1280x800 12.1" W - 1280x800 15.0" - 1024x768 (no TFM) 15.6" W - 1366x768 15.6" W - 1920x1080 18.5" W - 1366x768 18.5" W - 1920x1080 21.5" W - 1920x1080 24"W - 1920x1080		8.4" - 800x600 10.1" W - 1280x800 10.4" - 800x600 12.1" - 800x600 12.1" - 1024x768 12.1" W - 1280x800 15.0" - 1024x768 15.6" W - 1366x768 15.6" W - 1920x1080 17" - 1280x1024 18.5" W - 1366x768 18.5" W - 1920x1080 19" - 1280x1024 21.5" W - 1920x1080 24"W - 1920x1080		12.1" - 800x600 12.1" - 1024x768 15.0" - 1024x768 17" - 1280x1024 19" - 1280x1024		10.1" W - 1280x800 12.1" W - 1280x800 15.6" W - 1366x768 15.6" W - 1920x1080 18.5" W - 1366x768 18.5" W - 1920x1080 21.5" W - 1920x1080 24"W - 1920x1080
CUT-OUT	QT		HT				
FRONT USB	-		1 x USB 2.0, front, protected (Type-A)		-		
TOUCHSCREEN	Resistive 5 wires	P-CAP Multitouch	Resistive 5 wires			P-CAP Multitouch	
FRONT PANEL	Aluminium	True Flat Aluminium	Aluminium	True Flat Aluminium	True Flat Stainless Steel	True Flat Aluminium	
PROTECTION GRADE	IP65 - frontal						
VIDEO INPUT	MH/MQ		1 x DVI-D 1 x VGA				
	MHR/MQR		1 x RJ45 (remotation cable)				
USB	2 x USB 2.0, rear (Type-A)						
USB only MH/MQ	1 x USB 2.0 HUB input, rear						
REMOTATION	MHR/MQR						
	Remotation of DVI-D and USB 2.0 signals up to 100mt with Cat 5e SF/UTP cable or Cat 6A S/FTP cable						
POWER SUPPLY INPUT	24VDC (18÷32VDC) isolated						
	24VDC (optional, only on MH/MQ)						
	110V/230VAC (optional)						
OPERATING TEMPERATURE	0° ÷ +50°C						
APPROVALS	CE, cULus LISTED (508)						

MH/MHR200 / MQ/MQR200 [new]

Panel Mounting industrial monitors



The panel monitor family MQ200/MQR200 is available with the new front panels with minimized frame, with 16 million colours LED Backlight TFT LCDs from 12.1" to 24", in Wide aspect ratio, with aluminium front panel and a 5 wires resistive touchscreen, or aluminium and glass TrueFlat Multitouch front panels, with projected capacitive touchscreen.

Alternatively, the family MH200/MHR200 is available with 16 million colours LED Backlight TFT LCDs from 12.1" to 24", in 4:3, 5:4 and Wide aspect ratio, with aluminium or aluminium True flat front panels, 5 wires resistive touchscreen and an additional USB 2.0 port on front. As an alternative, the systems with 12.1", 15", 17" and 19" LCD can have a Stainless Steel

True Flat front panel. All versions with Wide LCDs are also available with aluminium and glass TrueFlat Multitouch front panels, with projected capacitive touchscreen. The monitors have an isolated 24 VDC power supply input or, as an alternative, a 110/230 VAC power supply. MH200 and MQ200 versions have a Display Port and a DVI-D video input, while

MHR200 and MQR200 versions integrate the remotation technology for DVI-D and USB 2.0 signals that allows the connection of the IPC within 100 meters with a Cat 5e SF/UTP or CAT6A S/FTP cable. Both versions include three USB 2.0 ports on the I/O shield and, as an option, an additional USB 2.0 port.



+ Highlights

- Industrial Monitor with 0°C÷50°C operating temperature
- 12.1" and 15" LCDs in 4:3 aspect ratio, 17" and 19" LCDs in 5:4 aspect ratio, 12.1", 15.6", 18.5", 21.5" and 24" LCDs in Wide aspect ratio
- Three USB 2.0 ports on the I/O shield and one additional USB 2.0 port (option)
- Isolated 24 VDC power supply input or 110/230 VAC power supply (optional)
- MHR200 and MQR200 version with remotation of DVI and USB 2.0 signals up to 100m
- CE, cULus LISTED (61010) certifications

Gallery



Remotation

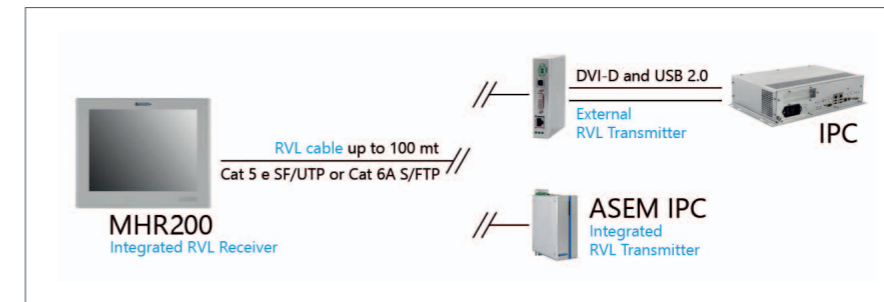

Technical data

	MQ200 / MQR200	MQ200-TFM / MQR200-TFM	MH200 / MHR200	MH200-TF / MHR200-TF
LED backlight TFT LCD	12.1" W - 1280x800 15.6" W - 1366x768 15.6" W - 1920x1080 18.5" W - 1366x768 18.5" W - 1920x1080 21.5" W - 1920x1080 24"W - 1920x1080		12.1" - 800x600 12.1" - 1024x768 15.0" - 1024x768 17" - 1280x1024 19" - 1280x1024	
CUT-OUT	QT		HT	
FRONT USB	-		1 x USB 2.0, front, protected (Type-A)	
TOUCHSCREEN	Resistive 5 wires	P-CAP Multitouch	Resistive 5 wires	
FRONT PANEL	Aluminium	True Flat Aluminium	Aluminium	True Flat Aluminium
PROTECTION GRADE	IP65 - frontal			
REMOTATION MHR/MQR	Remotation of DVI-D and USB 2.0 signals up to 100mt with Cat 5e SF/UTP cable or Cat 6A S/FTP cable			
VIDEO INPUT MH/MQ MHR/MQR	1 x DP 1 x DVI-D			
USB	1 x RJ45 (remotation cable) 3 x USB 2.0, rear (Type-A) 1 x USB 2.0 (Type -A optional)			
UBS only MH/MQ	1 x USB 2.0 HUB input, rear Type B			
POWER SUPPLY INPUT	24VDC (18÷32VDC) isolated 110V/230VAC (90÷264VAC, optional) isolated, autoranging			
OPERATING TEMPERATURE	0°÷50°C			
APPROVALS	CE, cULus LISTED (61010)			

MV100/MV200 - MVR100/MVR200 new

VESA Mounting industrial monitors



The VESA mounting monitors of the MV100/MVR100 and MV200/MV200R families are made of steel sheet chassis with anti-scratch powder coating, compatible with VESA 100 installation standard. They are available with 16 million colours LED Backlight TFT LCDs from 15.6" to 21.5", in Wide aspect ratio with aluminium front panels and 5 wires resistive touchscreen

or with aluminium and glass TrueFlat Multitouch front panels and projected capacitive touchscreen. The monitors have an IP54 protection grade and an isolated 24 VDC power supply input. The MV100 and MV200 versions have a DVI-D and a VGA video input, while the MVR100 and MVR200 versions integrate the

remotation technology for DVI and USB 2.0 signals that allows the connection of the IPC within 100 meters with a Cat 5e SF/UTP or CAT6A S/FTP cable. MV100/MVR100 versions include two USB 2.0 ports on the I/O shield, while MV200/MVR200 versions include three USB 2.0 ports. All versions have two USB 2.0 ports with external access, protected by a rubber cap.



Highlights

- VESA Mounting Monitor with 0°C÷50°C operating temperature
- Protection grade IP54
- 15.6", 18.5" and 21.5" LCDs in Wide aspect ratio
- Isolated 24 VDC power supply input
- MVR100/MVR200 versions with remotation of DVI and USB 2.0 signals up to 100m
- CE, cULus LISTED (61010) certifications

Gallery



Remotation

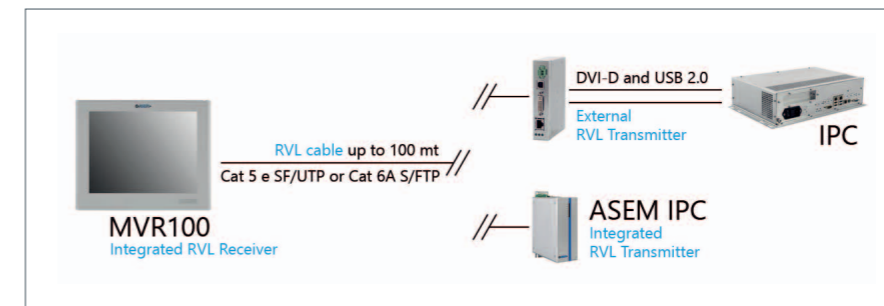

Technical data

	MV100/MV200	MV100/MV200 -TFM	MVR100/MVR200	MVR100/MVR200-TFM
LED backlight TFT LCD		15.6" W - 1366x768 15.6" W - 1920x1080 18.5" W - 1366x768 18.5" W - 1920x1080 21.5" W - 1920x1080"		
TOUCHSCREEN	Resistive 5 wires	P-CAP multitouch	Resistive 5 wires	P-CAP multitouch
FRONT PANEL	Aluminium	True Flat Aluminium	Aluminium	True Flat Aluminium
PROTECTION GRADE	IP54			
CASE	Installation	For VESA 100 mounting system		
	Material	Steel sheet metal		
	Colour	Anti-scratchable painted - RAL 9006		
REMOTATION	-		Remotation of DVI-D and USB 2.0 signals up to 100mt with Cat 5e SF/UTP cable or Cat 6A S/FTP cable	
VIDEO INPUT	MV100: 1xDVI-D, 1xVGA MV200: 1xDP, 1x DVI-D MV100R/MV200R: 1 x RJ45 (remotation cable)			
REAR ACCESS INTERFACES	MV100: 2 x USB 2.0 (Type A) - 1 x USB 2.0 HUB input, Type B ▪ MV200: 3 x USB 2.0 (Type A) - 1 x USB 2.0 HUB input, Type B MV100R: 2 x USB 2.0 (Type A) ▪ MV200R: 3 x USB 2.0 (Type A)			
EXTERNAL ACCESS INTERFACES	2 x USB 2.0 with protection cap			
POWER SUPPLY INPUT	24VDC (18÷32VDC) isolated			
OPERATING TEMPERATURE	0°÷50°C			
APPROVALS	CE, ULus LISTED (61010) pending			

MK100 / MKR100

Arm Mounting industrial monitors



The arm mounting monitors of the MK100/MKR100 family are made of a Full IP65 cast aluminium chassis, powder coated with anti-scratch treatment, compatible with the most used installation standards. The front button area is available in Hard-Wired or Fieldbus (EtherCAT Slave) versions and it is totally configurable. It allows to install light indicators, buttons, lever switches, keylock switches, encoders,

an emergency stop button and USB, Ethernet or RFID interfaces (described in the "Configurations and Options" section). They are available with 16 million colours LED Backlight TFT LCDs from 15.6" to 24", in Wide aspect ratio with aluminium True flat front panels and 5 wires resistive touchscreen or with aluminium and glass TrueFlat Multitouch front panels and projected capacitive

touchscreen. MK100/MKR100 monitors have an isolated 24 VDC power supply input. MK100 versions have a VGA and a DVI-D standard input. MKR100 versions integrate the remotation technology for DVI and USB 2.0 signals that allows the connection of the IPC within 100 meters with a Cat 5e SF/UTP or CAT6A S/FTP cable.



+ Highlights

- Full IP65 chassis
- Button area with up to 15 Ø22 elements, Hard-Wired or Fieldbus versions (EtherCAT Slave)
- Arm Mounting Monitor with 0°C÷50°C operating temperature
- 15.6", 18.5", 21.5" and 24" LCDs in Wide aspect ratio
- Isolated 24 VDC power supply input
- MKR100 version with remotation of DVI and USB 2.0 signals up to 100m
- CE, ULus LISTED (61010) certifications

Gallery

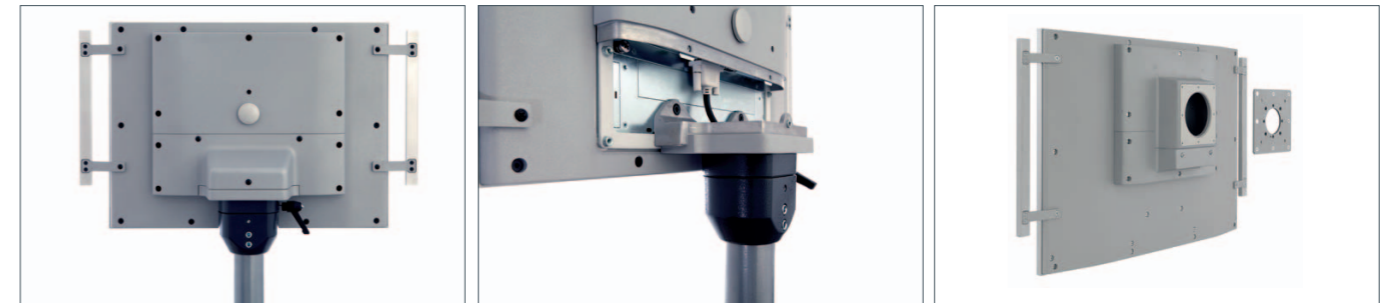

Remotation

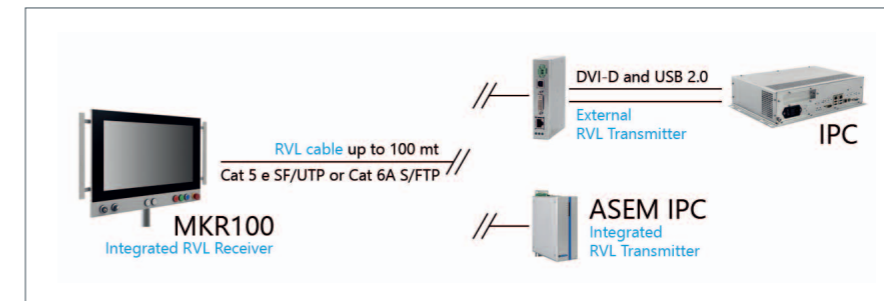

Technical data

	MK100-TF	MK100-TFM	MKR100-TF	MKR100-TFM
LED backlight TFT LCD	15.6" W - 1366x768 15.6" W - 1920x1080 18.5"W - 1366x768 18.5"W - 1920x1080 21.5" W- 1920x1080	15.6" W - 1366x768 15.6" W - 1920x1080 18.5"W - 1366x768 18.5"W - 1920x1080 21.5" W- 1920x1080 24" W - 1920x1080	15.6" W - 1366x768 15.6" W - 1920x1080 18.5"W - 1366x768 18.5"W - 1920x1080 21.5" W- 1920x1080	15.6" W - 1366x768 15.6" W - 1920x1080 18.5"W - 1366x768 18.5"W - 1920x1080 21.5" W- 1920x1080 24" W - 1920x1080
TOUCHSCREEN	Resistive 5 wires	P-CAP Multitouch	Resistive 5 wires	P-CAP Multitouch
FRONT PANEL	True Flat Aluminium	True Flat Aluminium	True Flat Aluminium	True Flat Aluminium
PROTECTION GRADE	Full IP65			
CASE	Installation	For VESA 75/100 or for pole / suspension arm mounting. system compatible with RITTAL CP40 / ROLEC TARAPLUS / HASEKE HLT KUPPLUNG 48		
	Material	Aluminium alloy EN AB46400		
	Colour	Anti-scratchable painted - RAL 9006		
	Accessories	Side handles, perimetral handle, keyboard holder kit		
BUTTONS AREA (optional)	See "Configurations & Options" section at the end of the brochure			
REMOTATION			Remotation of DVI-D and USB 2.0 signals up to 100mt with Cat 5e SF/UTP cable or Cat 6A S/FTP cable	
VIDEO INPUT	1 x VGA 1 x DVI-D		1 x RJ45 (remotation cable)	
USB INPUT	2 x USB 2.0 rear (type -A)			
REAL INTERNAL ACCESS INTERFACES	2 x USB 2.0 (Type A)			
POWER SUPPLY INPUT	24VDC (18÷32VDC) isolated			
OPERATING TEMPERATURE	0°C÷50°C			
APPROVALS	CE, ULus LISTED (61010)			

MK200 / MKR200 new

ARM Mounting Industrial Monitor



The arm mounting monitors of the MK200/MKR200 family are made of a Full IP65 cast aluminium chassis, powder coated with anti-scratch treatment, compatible with the most used installation standards. The front button area is available in Hard-Wired version and it is totally configurable. It allows to install light indicators, buttons, lever

switches, keylock switches, encoders, an emergency stop button and USB, Ethernet or RFID interfaces. MK200/MKR200 monitors are available with the new front panels with minimized frame, in aluminium and glass True Flat Multitouch and projected capacitive touchscreen, with 16 million colours LED Backlight TFT LCDs from 15.6" to 24", in

Wide aspect ratio. MK200/MKR200 monitors have an isolated 24 VDC power supply input. MK200 versions have a Display Port video input and a DVI-D video input, while MKR100 versions integrate the remotation technology for DVI and USB 2.0 signals that allows the connection of the IPC within 100 meters with a

Cat 5e SF/UTP or CAT6A S/FTP cable. Both versions include three USB 2.0 ports on the I/O shield.



+ Highlights

- Full IP65 chassis
- Button area with up to 15 Ø22 elements, Hard-Wired
- Arm Mounting Monitor with 0°C÷50°C operating temperature
- Three USB 2.0 ports on the I/O shield.
- 15.6", 18.5", 21.5" and 24" LCDs in Wide aspect ratio
- Isolated 24 VDC power supply input
- MKR200 version with remotation of DVI and USB 2.0 signals up to 100m
- CE, ULus LISTED (61010) certifications)

Gallery



Remotation

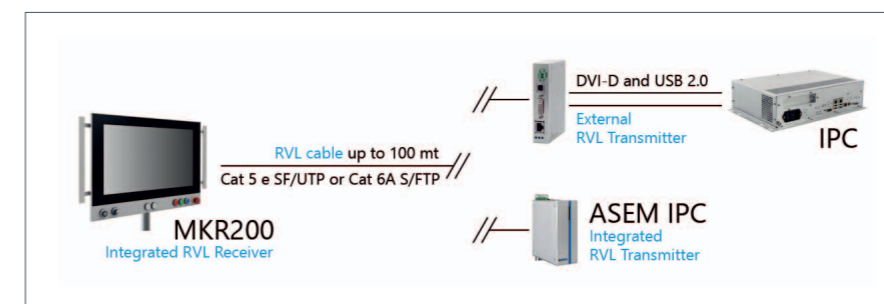

Technical data

	MK200	MKR200-TFM
LED backlight TFT LCD		15.6" W - 1366x768 15.6" W - 1920x1080 18.5" W - 1366x768 18.5" W - 1920x1080 21.5" W - 1920x1080 24" W - 1920x1080"
TOUCHSCREEN		P-CAP multitouch
FRONT PANEL		True Flat Aluminium
PROTECTION GRADE		Full IP65
CASE Installation	For VESA 75/100 or for pole/suspension arm mounting system compatible with RITTAL CP40/ROLEC TARAPLUS/HASEKE ULT KUPPLUNG 48	
Material	Aluminium alloy AN AB46400	
Colour	Anti-scratchable painted - RAL 9006	
Accessories	Side handles, perimetral handle, keyboard holder kit	
BUTTONS AREA (optional)	See "Configurations & Options" section at the end of the brochure	
REMOTATION	-	Remotation of DVI-D and USB 2.0 signals up to 100mt with Cat 5e SF/UTP cable or Cat 6A S/FTP cable
VIDEO INPUT	1 x Display Port 1 x DVI-D	1 x RJ45 (remotation cable)
USB	2 x USB 2.0 rear (Type-A)	
REAL INTERNAL ACCESS INTERFACES	3 x USB 2.0 rear (Type-A) 1 x USB 2.0 HUB input (Type-B) only MK200	
POWER SUPPLY INPUT	24VDC (18÷32VDC) isolated	
OPERATING TEMPERATURE	0°C÷50°C	
APPROVALS	CE, ULus LISTED (61010) pending	

MX200 / MXR200 [new]

Stainless Steel ARM Mounting Industrial Monitor



The arm mounting monitors of the MX200/MXR200 are specifically developed for food & beverage, pharma & chemical applications and they feature a stainless steel (AISI 304L) chassis, 6-hole "VESA 100" mounting with M5 screws. A mechanical adapter is available for arm mounting compatible with Ø 48 mm tubes for TOP and BOTTOM solutions. Monitors have slopping surfaces to sloping surfaces

to avoid dust accumulation, hygienic screws with under-head gasket and blue silicone gaskets. Protection grade is full IP69K for the version without button area and USB with external access, or Full IP65 for the button area version. The front button area is available in Hard-Wired version and it is customer-configurable when ordering. It allows to install light indicators, buttons, lever switches,

keylock switches, encoders, an emergency stop button and USB, Ethernet or RFID interfaces. MX200/MXR200 monitors are available with True Flat stainless steel front panel and 5 wires resistive touchscreen, with 16 million colours LED Backlight TFT LCDs 18" in Wide aspect ratio. MX200/MXR200 monitors have an isolated 24 VDC power supply input. MX200 monitors have a

Display Port video input and a DVI-D video input, while MXR200 versions integrate the remotation technology for DVI and USB 2.0 signals that allows the connection of the IPC within 100 meters with a Cat 5e SF/UTP or CAT6A S/FTP cable.



+ Highlights

- Arm Mounting monitor with 0°C÷50°C operating temperature
- Stainless Steel chassis with Full IP69K protection grade
- Configurable Hard-wired Button area
- Three USB 2.0 ports on the I/O shield.
- 18.5" LCDs in Wide aspect ratio
- Isolated 24 VDC power supply input
- MXR200 version with remotation of DVI and USB 2.0 signals up to 100m
- CE, ULus LISTED (61010) certifications

Gallery



Remotation

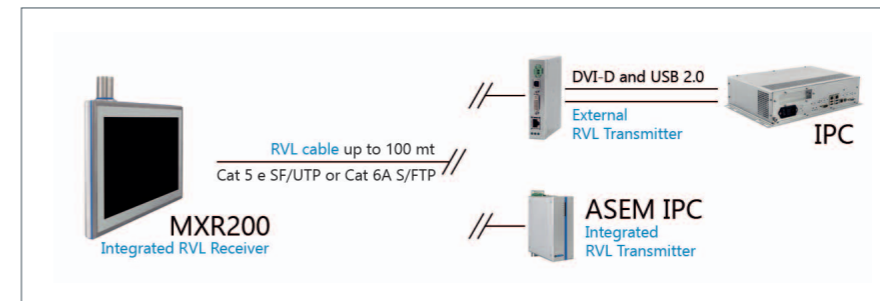

Technical data

	MX200-TFX	MXR200-TFX
LED backlight TFT LCD	18.5" W - 1366x768 18.5" W - 1920x1080"	
TOUCHSCREEN	Resistive 5 wires	
FRONT PANEL	True Flat Stainless Steel	
PROTECTION GRADE	Full IP69K (without button area or external USB) Full IP67 (without button area, with 2 x USB 3.0) Full IP65 (with button area)	
CASE	Installation	With customised ASEM 10x10 attachment with 6M5 screws in stainless steel AISI 304
	Material	Stainless Steel AISI 304L
BUTTONS AREA (optional)	See "Configurations & Options" section at the end of the brochure	
REMOTATION	-	Remotation of DVI-D and USB 2.0 signals up to 100mt with Cat 5e SF/UTP cable or Cat 6A S/FTP cable
VIDEO INPUT	1 x DVI-D 1x Display Port	1 x RJ45 (remotation cable)
USB	3 x USB 2.0, internal, rear (Type-A) only MX200: 1x USB 2.0 HUB input rear, Type B	
POWER SUPPLY INPUT	24VDC (18÷36VDC) isolated	
REAL EXTERNAL ACCESS	2 x USB 2.0 with protection cap	
OPERATING TEMPERATURE	0°C÷50°C	
APPROVALS	CE, ULus LISTED (61010)	

Video remotation solutions

Remote Video Link (RVL) is the ASEM solution for the remotation of DVI-D and USB signals

The solution is composed by the RVL Receiver, the RVL Transmitter and a simple Cat. 6A S/FTP or Cat. 5e SF/UTP Ethernet cable and allows to connect a monitor up

to 100 meters far from the IPC. The RVL Receivers and Transmitters are integrated in several ASEM Industrial PCs and monitors or can be supplied as external modules

to create long distance connections between PCs and monitors manufactured by ASEM or by other suppliers.



Configurations & Options

Integrated Receiver and Transmitter

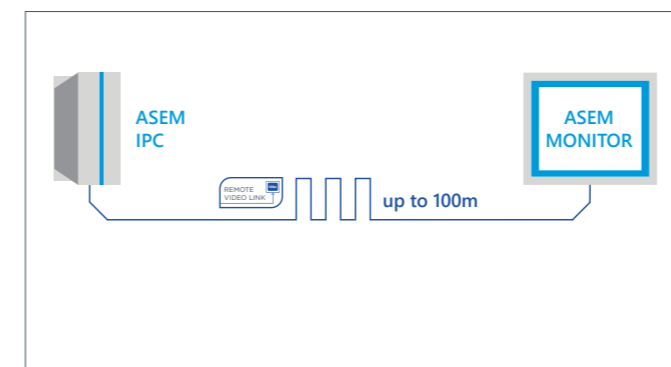

External Receiver and integrated Transmitter

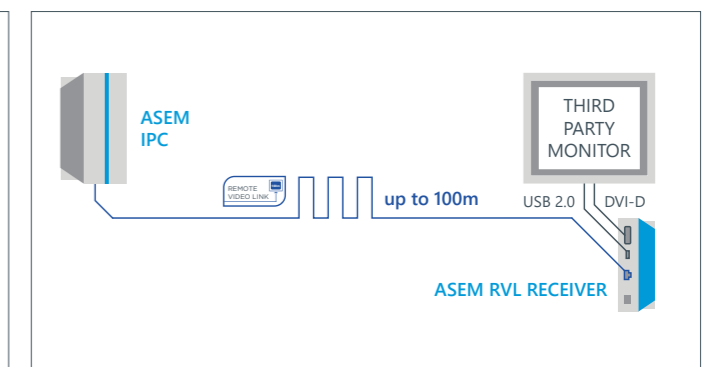

Integrated Receiver and external Transmitter

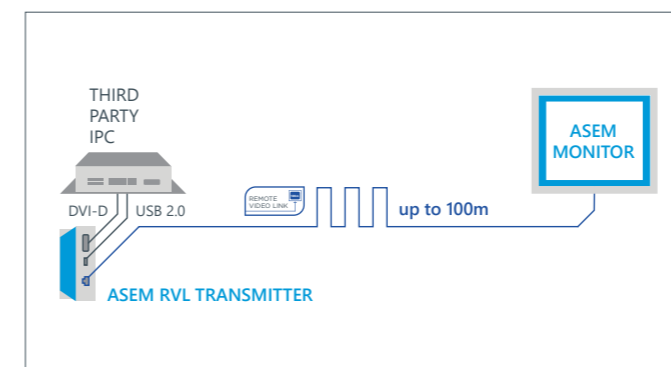

External Receiver and Transmitter

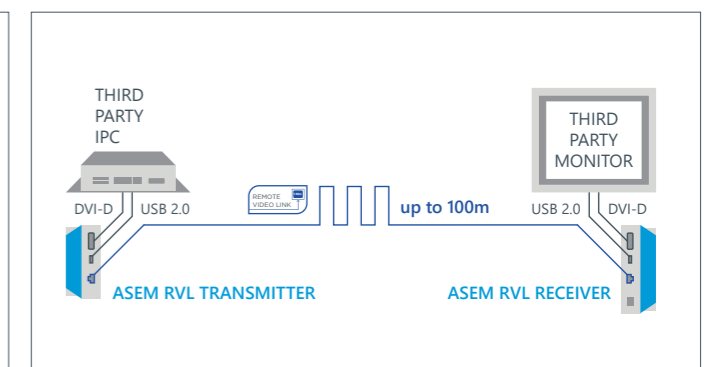

To connect IPCs with a dual mode Display Port to the DVI-D input of the external transmitter, an adapter cable is available as an option.

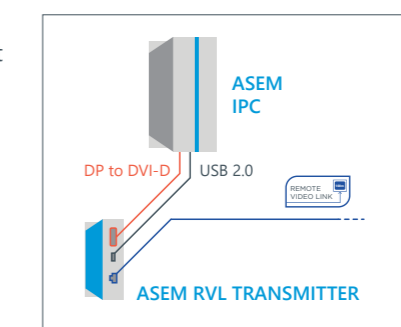

Fieldbuses boards



NETcore® X

NETcore®X fieldbus boards are the link between the IPC and the I/O devices on field and enable control and visualization applications to receive data from the field according to the industrial fieldbuses available.

To be integrated on all ASEM systems, different formats are available, according to the systems they are addressed to.

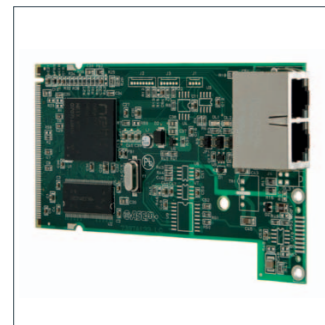

NETcore® X Industrial Ethernet

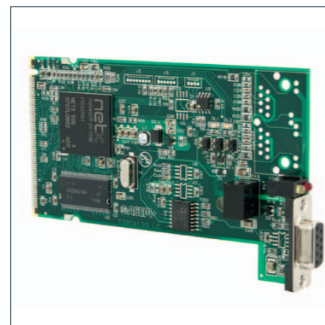

NETcore® X Profibus

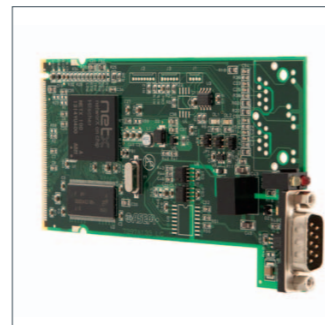

NETcore® X CANopen

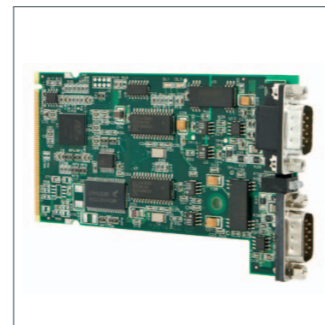

Dual CAN-RAW

Board	Protocols	HT/QT/PB/BM	VK3200	PCI/APCI	MiniPCI / MiniAPCI
NETcore X PROFIBUS	Profibus DP Master/Slave, MPI	✓	✓	✓	✓
NETcore X CANopen	CANopen Master/Slave	✓	✓	✓	✓
NETcore X Industrial Ethernet	EtherCAT Master/Slave	✓	-	✓	✓
	PROFINET IO Controller/Device	✓	✓	✓	✓
CAN RAW	Ethernet/IP Scanner/Adapter	✓	✓	✓	✓
	CANopen Master in combination with CODESYS (2 x isolated channels also with 512kB NVRAM)	-	-	✓	✓
NVRAM	512kB static RAM for SoftPLC	-	-	-	✓
ETHERNET	EtherCAT Master in combination with CODESYS	-	-	✓	✓

NETcore®X and proprietary application

A DLL library is available for developing applications under Win32 or WinCE operating systems. All DLL programming languages such as C, C++ or .NET are available.

NETcore®X with CODESYS

Using NETcore®X fieldbus boards, the integration with CODESYS is automatic and does not require any code to implement the communication stack.

NETcore®X with PremiumHMI

Premium HMI uses NETcore®X boards with SIEMENS MPI and PROFIBUS Slave protocols, using a dedicated communication driver.

Wireless modules



Wifi and mobile modules

Wireless modules allow ASEM systems to be accessible from a remote position, without a cable connection. According to specific needs, Wi-Fi adapters for local connection and/or 2G/3G/4G-LTE modems (for internet connection in covered areas) can be used.

Several formats are available, according to the systems that will include the device/s.



WiFi / Bluetooth adapter and 2G/3G/4G modem

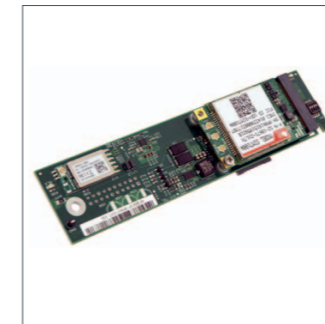

Carrier for RT40



Carrier for HT Series

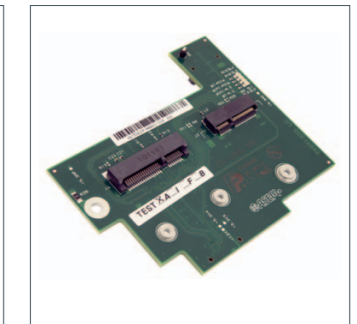

Carrier per VK

		Panel ARM based IPCs	Panel IPCs / Box IPCs	Arm Mounting IPCs
WI-FI + BLUETOOTH	Standard	IEEE 802.11 b/g/n	IEEE 802.11 a/b/g/n + Bluetooth V4.0 LE/ V3.0+HS/ V2.1+EDR	
	Features	Client mode	Client / Access point mode (Wi-Fi)	
	Security	WEP, TKIP, AES, WPA and WPA2	64/128-Abits WEP, WPA, WPA2 (Wi-Fi)	
	Rx Sensitivity	802.11b -80dBm@8%, 802.11g -70dBm@10%, 802.11n -64dBm@10%	802.11a: -73dBm / 802.11g: -74dBm / 802.11n(2,4GHz): -72dBm@HT20, -69dBm@HT40 / 802.11n(5GHz): -69dBm@HT20, -68dBm@HT40 (Wi-Fi) <0.1% BER at -70dBm (Bluetooth)	
	Antenna	1 x RP-SMA-F	2 x RP-SMA-F	
CELLULAR NETWORK	Standard	2G/3G/4G LTE CAT4 Multiband up to 50Mbps upload / 150Mbps download		-
	Antenna	1 x SMA-F connector		-
	SIM	1x SIM card socket push-push type		-
SUPPORTED O.S.		Windows CE Linux Yocto (2.2.1)	Microsoft Windows 7 Microsoft Windows 8.1 Microsoft Windows 10	

UPS INTEGRATED in IPCs

ASEM has developed an integrated UPS (Uninterruptible Power Supply) system for its IPCs to prevent sudden shutdowns, resulting in data loss or damage, following an unexpected loss of the primary power supply.

by the ASEM R&D team and includes:
 → A hardware section capable of switching in negligible time (in the order of microseconds) the power source from the primary voltage to the battery and vice versa;
 → A configurable hardware section to monitor the battery status and manage the charge and discharge phases;

→ A microcontroller-based control section that manages the system states and it interfaces with the PC;
 → A high-level, Windows-based, user-configurable software section that diagnoses system and battery pack status and it manages shutdown.
 The architecture is common to all systems and it is

customised by configuring specific parameters according to the type of use and consumption to optimise battery life.

To ensure maximum reliability and immunity to interference, the control electronics are integrated into the power supply module, so that the communication interfaces between the PC and the UPS remain within the system. The battery packs can be installed either directly on the system (fig.1) or separately up to a five metres distance (fig.2), so that the best position can be chosen to simplify wiring or replacement operations. The control logic, arranged on several levels, is completely designed, and developed

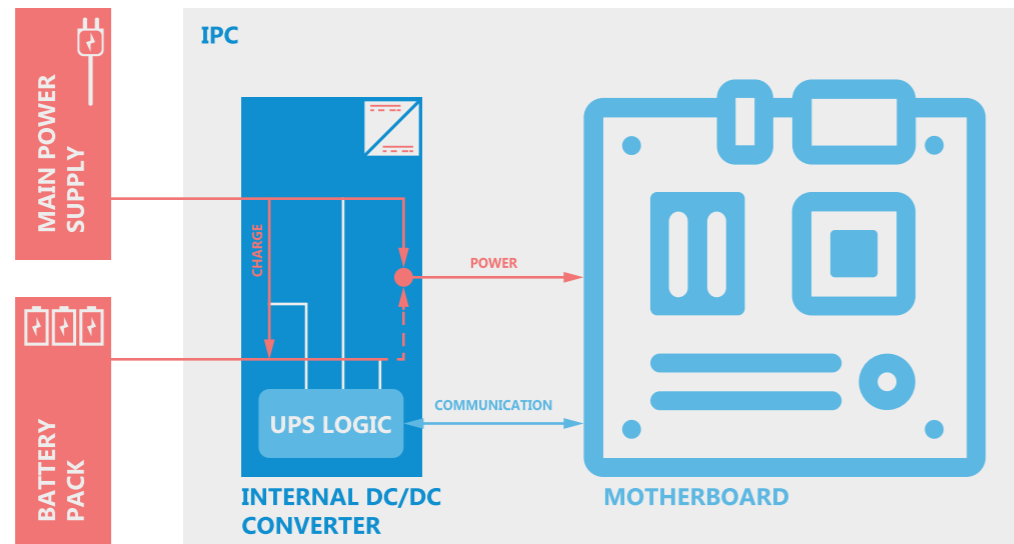

Fig. 1



Fig. 2

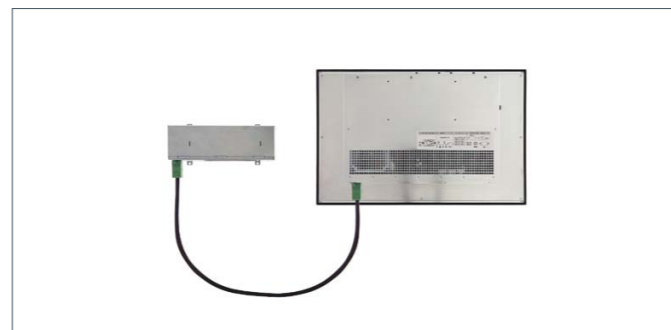
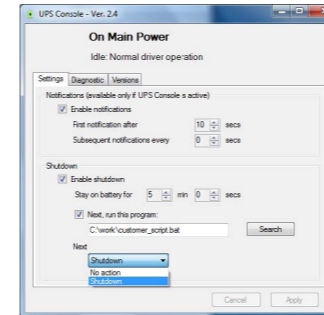

Fig. 3



Software

The operation of UPS systems is managed by high-level software, developed for the Windows environment, divided into two parts:
 → a service responsible for monitoring supply voltage and the battery status and managing a possible shutdown;

→ a graphic application usable to configure the behaviour in the event of a primary voltage failure and to check the diagnostics.
 In addition, to preserve the battery from abnormal degradation and to avoid sudden shutdowns, if a voltage lower than the minimum is measured during

the discharge phase, a regular system shutdown is commanded regardless of the parameters set.

+ Highlights

- Configurable switch-off range from 10 seconds to 10 minutes
- Information about remaining autonomy calculated on real system consumption
- Real-time battery status diagnostics
- Log functions with data historicization
- Integration with user application

Lead-acid batteries

Lead-acid cell battery packs, compared to more modern technologies, have significant size and dimensions, but they are able to provide high peak currents and can operate in a wide temperature range (far beyond the 0 - 50 °C

guaranteed for the systems). ASEM battery packs consist of 6 elements for a nominal voltage of 12 V and they can provide a maximum of 100 W for approximately 2 minutes. They also incorporate a temperature sensor and a protection circuit that

interrupts the connection if the current is too high or the voltage too low.



Nickel metal hydride batteries

Battery packs with Ni-MH cells are characterised by their smaller size compared to lead-acid batteries and by lower self-discharge during storage.

ASEM battery packs consist of 10 cells with a nominal voltage of 12 V and can provide a maximum of 60 W for approximately 10 minutes. They also integrate a temperature sensor, a protection circuit that

interrupts the connection if the current is too high or the voltage too low, and a switch to disconnect the battery during transport.



Front panels

True Flat technology

ASEM realizes the True Flat front panel through a special manufacturing process which takes place in a clean room to avoid environmental contamination such as dust or airborne microbes.

In this process, using an Optically Clear Adhesive (OCA) a thin polyester film is glued on the touchscreen, then the two components are attached on the Aluminium front panel.



Stainless Steel True Flat Front Panel

Panel IPCs with Stainless Steel True Flat front panels without USB port on the front are particularly used in pharmaceutical and food & beverage industries.



Glass Multitouch technology

All Panel IPC and monitor families are available with the new generation of Multitouch front panels in 7", 10.1", 12.1", 15.6", 18.5", 21.5" and 24" screen sizes with Wide aspect ratio. Glass projected Capacitive Touchscreen Technology allows mobile gestures such as zoom, swipe and rotate (even with work gloves), now

increasingly adopted in the factory automation. Multitouch front panels are made of a robust aluminium frame and a tempered glass surface in a completely true-flat design that gives maximum resistance to environmental influences and facilitates cleaning.

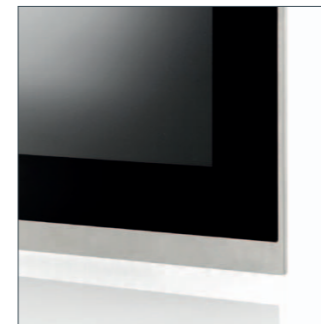

IP69K stainless steel front panel

The new stainless-steel front panels with an IP69K protection degree are specifically developed for food & beverage, pharma & chemical applications. They

are equipped with hygienic silicone gaskets and the sturdy front film is specially designed to withstand water washing with high-pressure.



Configurable button area for Arm Mounting IPCs and Monitors

The button area of the VK3200 and MK100/ MKR100 Arm Mounting systems is totally configurable at the order, depending on customer's requirements, and allows front access for further modifications and/or integrations.

Connections
The single elements of the button area can be connected in two ways: hard wired or via fieldbus.

Hard wiring
With the hard wired connection it is possible to install up to eight elements (excluding the USB, Ethernet and RFID interfaces), whose wiring is brought to two clamps, accessible from the back.

Fieldbus button area
The implemented fieldbus standard is EtherCAT. The quantity of elements that is possible to install on the systems with fieldbus button area depends on the display size: up to 9 with the 15.6" LCD, up to 11 with the 18,5" LCD, up to 13 with the 21,5" LCD and up to 15 with the 24" LCD, including USB, Ethernet, RFID interfaces and the emergency stop button.



Front access to the wiring of the button area



View of the rear clamps of a hard wired button area



View of the rear connectors of a Fieldbus button area

Elements for VK and MK/MKR

A wide range of elements is available to compose the button area of the Arm Mounting systems.

LED indicators
→ LED lit (5 colours available)

Push buttons
→ unlit
→ LED lit (5 colours available)
→ with custom exchangeable symbol
→ for ATX mode power up

Emergency stop button
→ with rotating unlock movement
→ double contact

Keylock switch and levers
→ with key
→ keyless LED lit
→ with 2 or 3 positions

Buzzer

Incremental Encoder

Communication ports
With IP65 protection cap
→ USB port
→ Ethernet port

RFID
On Ø 22 element
→ LF (125 kHz)
→ HF (13,56 MHz)



Configurable button area for stainless steel monitor

The button area of the MX monitor is totally configurable at the order, depending on customer's requirements and allows front access for further modifications and/or integrations.

Connections
The single elements of the button area can be connected in hard wired version and it is possible to install led indicators, push buttons, keylock switch and levers and an emergency stop button.



Button area MX family

Elements for MX/MXR

Button area customer-configurable

Ø22 elements

LED indicators
→ 5 colours available (red, yellow, green, blue, white)

Push buttons
→ Unlit
→ LED lit (5 colours available: red, yellow, green, blue, white)

Keylock switch and levers
→ with key
→ keyless LED lit
→ with 2 or 3 positions, with or without restraint



Ø 30 stainless steel, low profile

LED indicators
→ 5 colours available (red, yellow, green, blue, white)

Push buttons
→ Unlit
→ LED lit (5 colours available: red, yellow, green, blue, white)

Keylock switch and levers
→ with key
→ keyless LED lit
→ with 2 or 3 positions, with or without restraint



Emergency stop button

→ Stainless steel head
→ with rotating unlock movement



Mechanical accessories for VK and MK systems

Side handles

Kit composed of two aluminium side handles is available for simplifying system moving.



Perimetral handle

A perimetral handle to simplify system movements and protect the operator from accidental impacts.

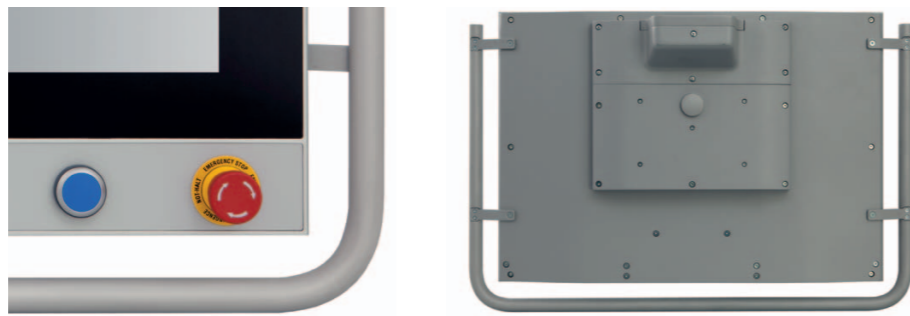

Keyboard holder kit

Keyboard holder kit, including a cable hole on the rear cover, with a rubber wire holder.



Arm mounting



Top arm mounting



Bottom arm mounting

VK and MK/MKR families

The Arm Mounting chassis is compatible with the most common installation standards, such as RITTAL CP40, ROLEC TARAPLUS, HASEKE ULT KUPPLUNG 48.

MX/MXR200 families

MX200 and MXR200 have a M5 six screws coupling arranged in a 100x100mm square. Optionally, a specific coupling is supplied, compatible with 48mm round support arm and suitable for top or bottom mounting.



VESA Standard

MV/MVR Families

MV/MVR chassis provide for VESA 100 standard

VK and MK/MKR Families

VK IPCs and MK/MKR Industrial Monitors provide for a chassis with VESA 100/75 coupling



VESA 100 on MV/MVR

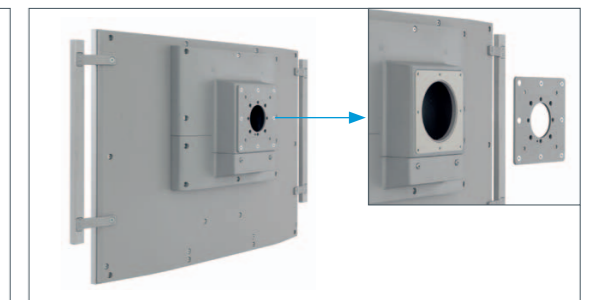

VESA 75 / VESA 100 on VK and MK/MKR



Technical support & Services

Technical support and service

Customer oriented philosophy

Providing a meticulous attention and a complete pre and post sales service is the foundational concept of our customer oriented service. All internal processes aim to ensure an excellent

product quality and a higher degree of flexibility, in order to be responsive to the ever-changing market needs. To ensure product and process quality, ASEM has adopted the standard UNI EN ISO 9001:2008 for its quality management system.



Intertek
9809792

Customer care

The customer care service is led by a team of technical specialists that answer with immediacy and clarity to customers' needs, not only by telephone and via the Internet, but also with on-site visits and technical training courses. To optimize the process of support and repair of systems and to minimize response time, ASEM offers some effective services:

"HELP DESK PHONE"

SERVICE can be accessed calling +39/0432/967250, from Monday to Friday from 09:00 to 12:30 and from 14:00 to 17:30. A qualified technician provides initial assistance, or starts the procedure for repairing or replacing the product (Return Material Authorization). Based on needs and the type of support required, the call may be turned to the most suitable ASEM specialist.

"HELP DESK ONLINE"

SERVICE allows access to the ASEM customer care service directly online, through the company website www.asem.it. This easy and quick tool allows to request technical assistance for any repair service, with real-time monitoring of the request status. In addition to these services, you can send any request for hardware, firmware and software support to the e-mail address suptec@asem.it.

Technical support

ASEM offers an excellent service of hardware and software consulting and assistance. It also includes a prompt and efficient system service assistance with the creation of ad-hoc operating system images, which allows to shrink the memory space needed for the installation of the operating systems (Microsoft Windows® CE,

Windows® XP and Windows® XP Embedded, Windows® 7, Windows® 7 Embedded, Microsoft Windows, Windows 8.1, Windows 10 2016, Windows 10 IoT Enterprise 2016, Linux and OS real time) maintaining only the necessary components for the proper functioning of the industrial PCs and the integration with the main applicative software.

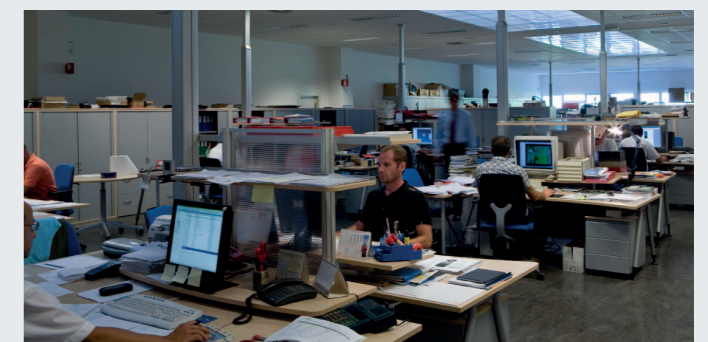

Lined writing area on the left page, consisting of 28 horizontal blue lines.

Lined writing area on the right page, consisting of 28 horizontal blue lines.

Handwriting practice area consisting of 25 horizontal blue lines.



A ROCKWELL AUTOMATION COMPANY

ASEM S.r.l.

ASEM | Artegnà | Headquarters

Via Buia 4

33011 Artegnà (UD) | Italia

Phone: +39/0432-9671

Fax: +39/0432-977465

email: industrialautomation@asem.it

website: www.asemautomation.com

USER INFORMATION

Copyright © ASEM 2021. All rights reserved. ASEM reserves the right to make changes, corrections and improvements to the products and programs described at its sole discretion and at any time, without any obligation to notify users. Nor can be excluded inconsistencies and inaccuracies, despite the continued pursuit of perfection. The content of this document is still subject to periodic review. Pictures, diagrams and examples in this document are for illustrative purposes only. ASEM decline any responsibility or liability for actual use based on the examples, diagrams and technical data therein reported. Premium HMI®, NETcore® are ASEM trademarks. Microsoft, Windows, Windows CE, Windows logo sare Microsoft Corporation trademarks. Celeron, Core™, Intel®, il logo Intel®, Intel® Atom, Intel Core™, Pentium Intel® Corporation trademarks in the United States and/or in other countrie. Other corporate, product or service names mentioned in this publication can refer to trademarks or service of other company.